

# STANDARD SORTIMENT 2019

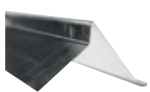

BYGNINGSPROFILER / AFVANDING / UDLUFTNING / TAGINDÆKNING  
KABELGENNEMFØRING / SIKKERHEDSANKRE / TAGKONSOLLER

ROOFER'S CHOICE

# PROFESSIONELT TILBEHØR TIL TAG & FACADE

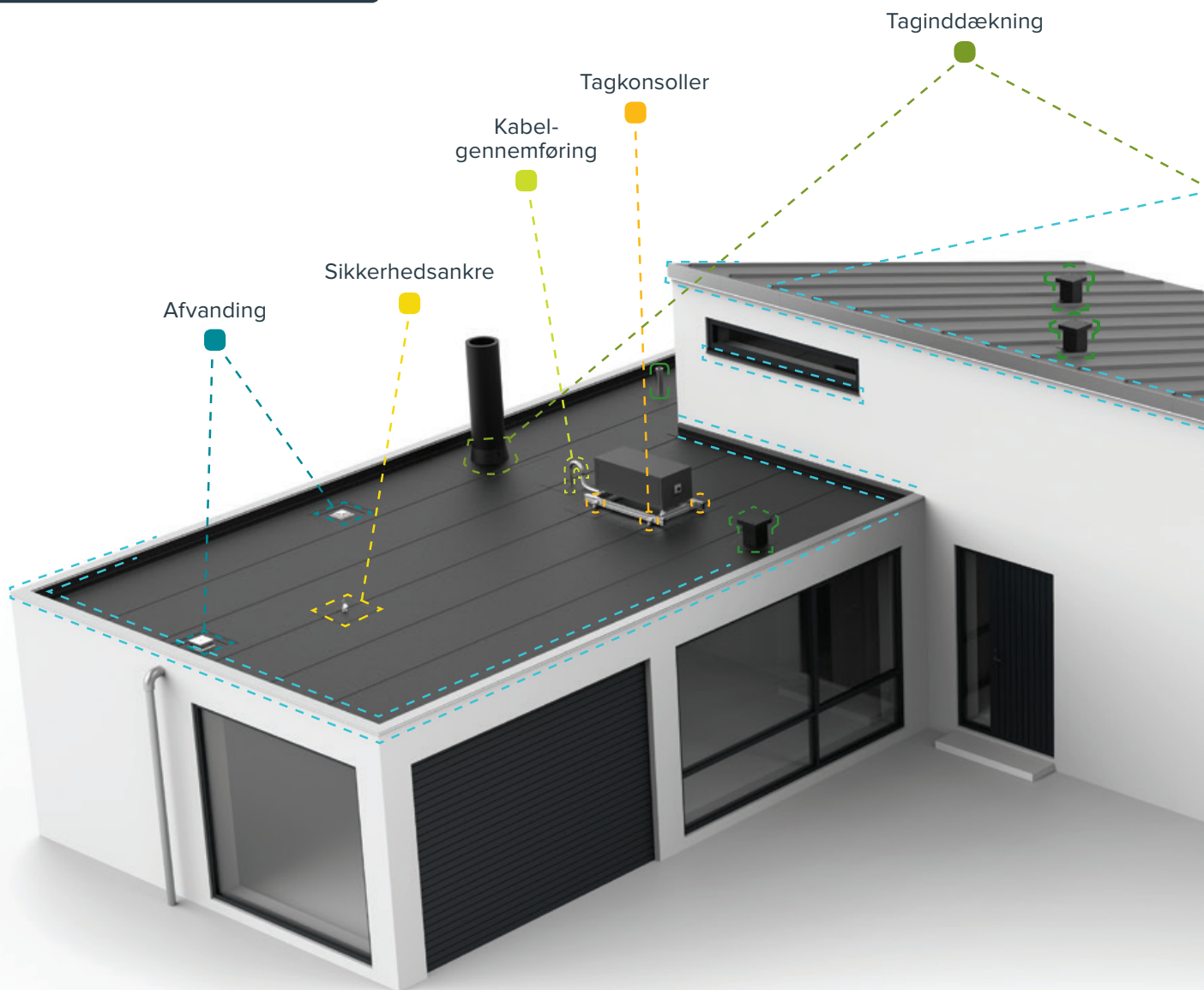

■ BYGNINGSPROFILER



■ AFVANDING



■ TAGINDDÆKNING



■ UDLUFTNING





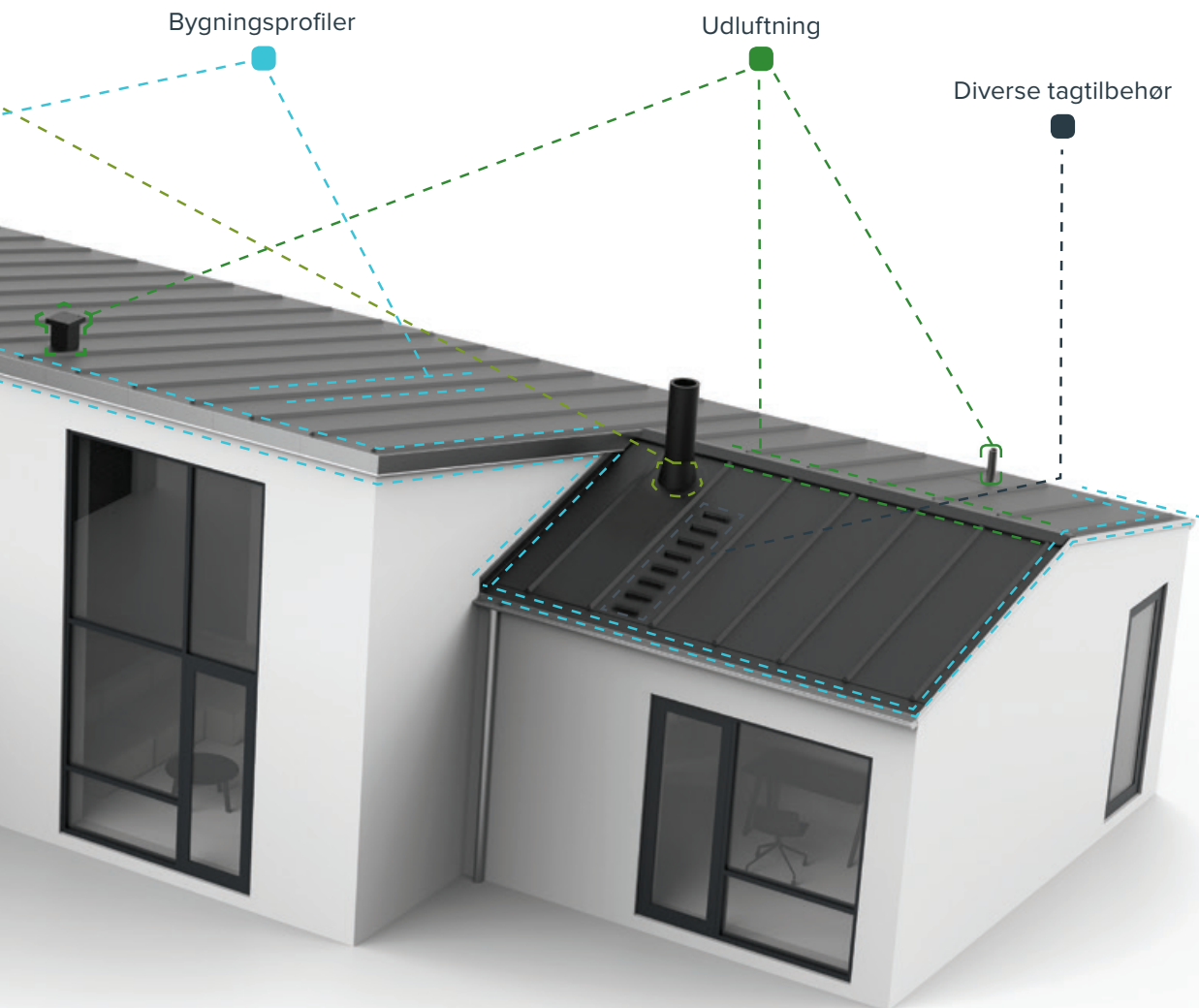

**KABELGENNEMFØRING**



**SIKKERHEDSANKRE**



**TAGKONSOLLER**

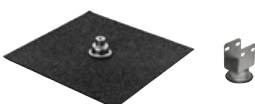

**DIVERSE TAGTILBEHØR**



BYGNINGS-  
PROFILER

AFVANDING

UDLUFTNING

TAGINDDÆKNING

KABEL-  
GENNEMFØRING

SIKKERHEDS-  
ANKRE

TAGKONSOLLER

INDDÆKNINGS-  
MATERIALER

DIVERSE  
TAGTILBEHØR



## 2019 STANDARDSORTIMENT

Velkommen til JUAL's standardsortiment for 2019!  
Igen i år har vi tilføjet en række nye produkter til det omfattende sortiment af tilbehør til tag og facade.

Som altid tilbyder vi:

- 
- ❁ PERSONLIG BETJENING
  - ❁ HURTIG REAKTIONSTID
  - ❁ FLEKSIBILITET
- 

**Intet er for stort, for småt eller for specielt.**  
Vi er klar til at hjælpe dig. Kontakt os i dag.

**76 83 11 33**  
**[jual@jual.dk](mailto:jual@jual.dk)**



BYGNINGS-  
PROFILER

06

BYGNINGS-  
PROFILER

AFVANDING

18

AFVANDING

UDLUFTNING

41

UDLUFTNING

TAGINDDÆKNING

48

TAGINDDÆKNING

KABELGENNEMFØRING

54

KABEL-  
GENNEMFØRINGSIKKERHEDS-  
ANKRE

56

SIKKERHEDS-  
ANKRE

TAGKONSOLLER

59

TAGKONSOLLER

INDDÆKNINGS-  
MATERIALER

62

INDDÆKNINGS-  
MATERIALER

DIVERSE TAGTILBEHØR

63

DIVERSE  
TAGTILBEHØR

# BYGNINGSPROFILER

JUAL VINDSKEDE M / UDLUFTNING	TEGNING (alle mål i mm)	ANTAL (pr. kolti)	1,0 mm alu. med asfalt (varenummer)	1,0 mm alu. sortlakeret (varenummer)	0,8 mm zink 14 (varenummer)
Vindskede med udluftning (klippet) Højre eller venstre		25 m	(40502/1H)	(40502-22H)	(40502-6H)
		25 m	(40502/1V)	(40502-22V)	(40502-6V)



VINDSKEDE MED  
UDLUFTNING, LEVERES  
SOM STANDARD I BÅDE  
ZINK OG ALUMINIUM

## TILBEHØR TIL JUAL VINDSKEDE M/ UDLUFTNING

TILBEHØR	ANVENDELSE	ANTAL (pr. kolti)	MATERIALE	(varenummer)
<b>Haft</b> Vinkel 	Til vandret/lodret fastgørelse af vindskede med udluftning	Efter ordre	1,5 mm galvaniseret stål	(4001502)
<b>Haft</b> Flad 	Til lodret fastgørelse af vindskede med udluftning		1,5 mm galvaniseret stål	(4002502)
<b>Låsebeslag</b> 	Til samling af vindskede med udluftning		1,0 mm galvaniseret stål	(4003502)
<b>S-Blindfals</b> Længde 175 mm 	Til samling af forkanter på vindskede med udluftning		0,6 mm aluminium 0,6 mm sort aluminium Zink 12 / 0,65 mm	(4004502) (4004502-22) (4004502-3)

# VINDSKEDE M/ UDLUFTNING

## [BESTILLING]



Vindskede m/ udluftning og fabriksfremstillede hjørner til både flade tage og hældningstage laves på mål efter kundens ønske.

Specialudgave:  
(målene A, B, C og V skal angives ved bestilling)

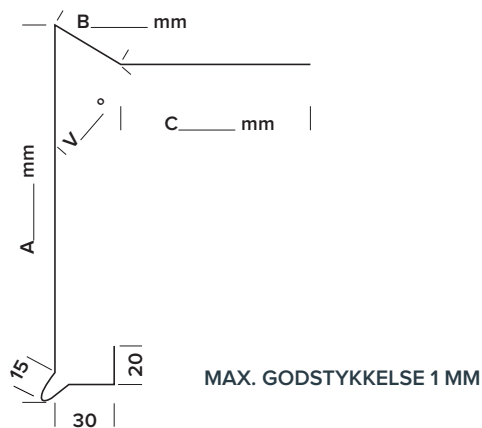

Længde pr. stk. (mm): \_\_\_\_\_

Antal (stk.): \_\_\_\_\_

Materiale: \_\_\_\_\_

Materialetykkelse (mm): \_\_\_\_\_

Ordre  Prisforespørgsel

Angiv hjørneklip jf. side 16: \_\_\_\_\_

Evt. bemærkninger: \_\_\_\_\_

Send din bestilling på mail til [jual@jual.dk](mailto:jual@jual.dk) – eller via fax på 75 69 37 37.

KONTAKTPERSON: \_\_\_\_\_ MOBIL: \_\_\_\_\_

FIRMANAVN: \_\_\_\_\_



## 1,0 MM ALUMINIUM

JUAL TAGFOD / MURAFDÆKNING	TEGNING (alle mål i mm)	ANTAL (pr. kolli)	1,0 mm alu. vejrbest. (varenummer)	1,0 mm alu. sortlakeret (varenummer)
Tagfod 12 55 x 100 mm		Uden asfalt	(27020)	(27020-22)
		Med asfalt	(27020/1)	–

NYHED

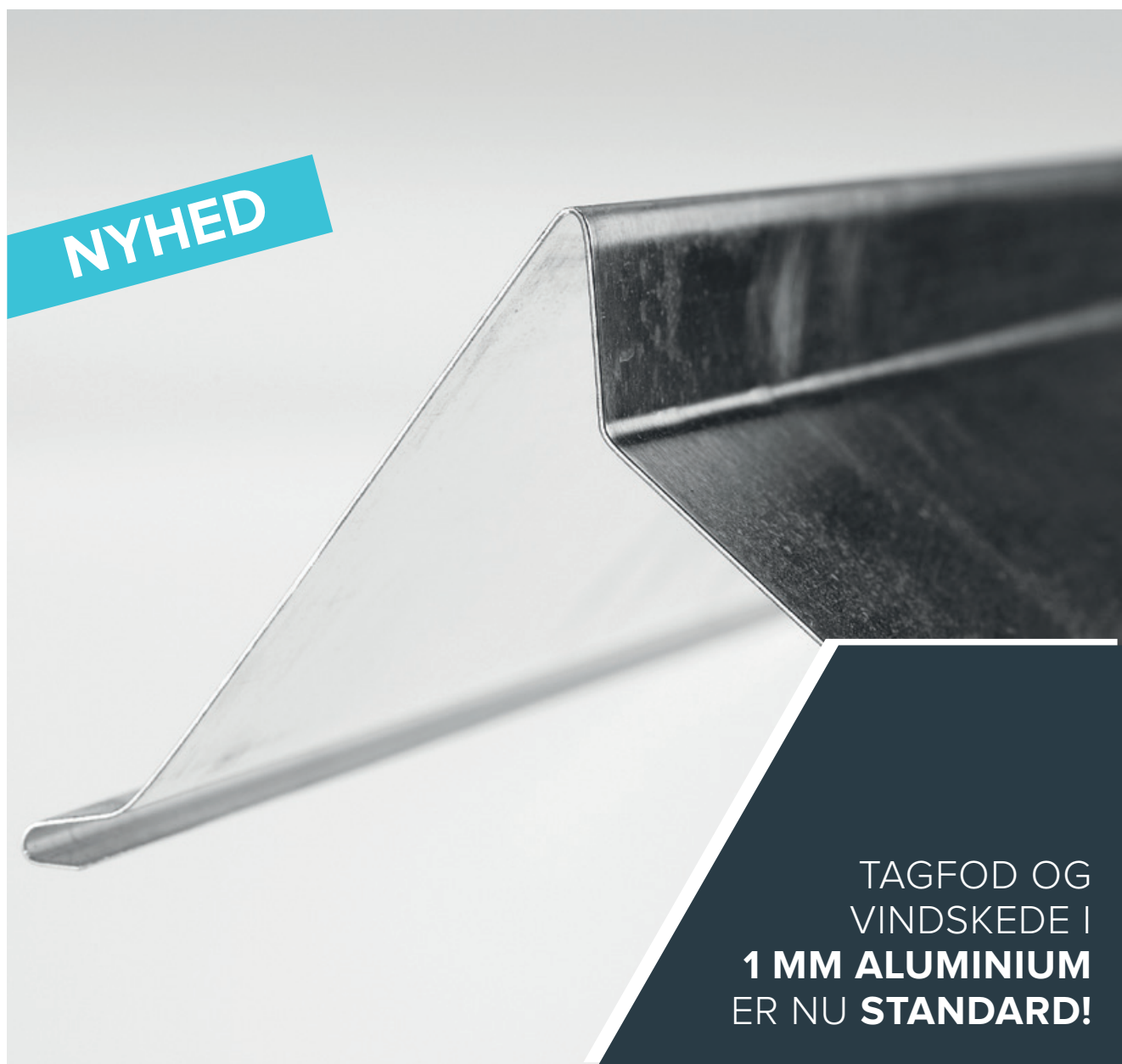

JUAL VINDSKEDE	TEGNING (alle mål i mm)	ANTAL (pr. kolli)	1,0 mm alu. vejrbest. (varenummer)	1,0 mm alu. sortlakeret (varenummer)
Vindskede 18 100 mm flange (ikke klippet)		Uden asfalt	(40520)	(40520-22)
		Med asfalt	(40520/1)	–

NYHED

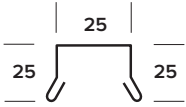
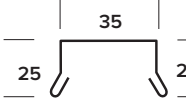
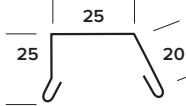
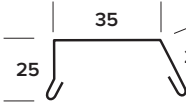
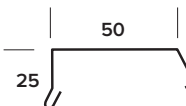
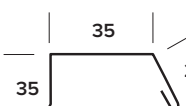

TAGFOD OG  
VINDSKEDE I  
**1 MM ALUMINIUM**  
ER NU **STANDARD!**

## 0,6 MM ALUMINIUM

JUAL KAPSEL	TEGNING (alle mål i mm)	ANTAL (pr. kolli)	0,6 mm alu. vejrbest. (varenummer)	0,6 mm alu. sortlakeret (varenummer)	0,65 mm zink 12 (varenummer)
Kapsel 5 S	 L = 1000 mm	50 m	(8001)	(8001-22)	(8001-3)
Kapsel 5 B	 L = 1000 mm	50 m	(8002)	(8002-22)	(8002-3)
Kapsel 9-2525	 L = 1000 mm	100 m	(15001) (15001m)	(15001-22) (15001-22m)	(15001-3) -
Kapsel 9-2535	 L = 1000 mm	100 m	(15002) (15002m)	(15002-22) (15002-22m)	(15002-3) -
Kapsel 9-2550	 L = 1000 mm	100 m	(15002-2550) (15002-2550m)	(15002-2550-22) (15002-2550-22m)	(15002-2550-3) -
Kapsel 9-3535	 L = 1000 mm	100 m	(18002) (18002m)	(18002-22) (18002-22m)	(18002-3) -
Kapsel 9-3550	 L = 1000 mm	100 m	(18002-3550) (18002-3550m)	(18002-3550-22) (18002-3550-22m)	(18002-3550-3) -
Universal Kapsel 27	 L = 1000 mm	100 m	(19001)	(19001-22)	-

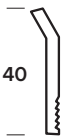
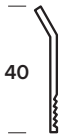
JUAL KLEMLISTE	TEGNING (alle mål i mm)	ANTAL (pr. kolli)	MATERIALE	(varenummer)
Klemliste standard 2,0 mm aluminium		Aflange huller pr. 200 mm	2,0 mm elox. aluminium	(72200)
		L = 2000 mm	2,0 mm sortlak. aluminium	(72300)
Klemliste discount 1,3 mm aluminium		Aflange huller pr. 200 mm	1,3 mm elox. aluminium	(72203)
		L = 2000 mm		

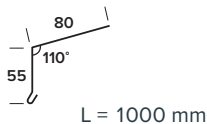
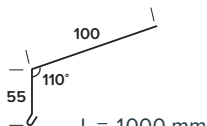
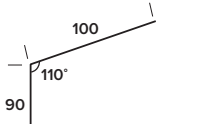
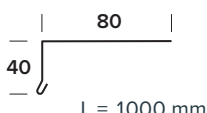
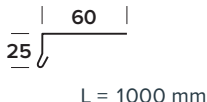

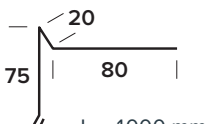
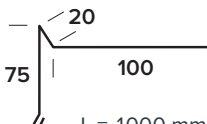
JUAL TAGFOD / MURAFDÆKNING	TEGNING (alle mål i mm)		ANTAL (pr. kolli)	0,6 mm alu. vejrbest. (varenummer)	0,6 mm alu. sortlakeret (varenummer)	0,65 mm zink 12 (varenummer)
Tagfod 12 55 x 80 mm		Uden asfalt	100 m	(27001)	(27001-22)	(27001-3)
		Med asfalt	100 m	(27001/1)	–	(27001-3/1)
Tagfod 12 55 x 100 mm		Uden asfalt	50 m	(27010)	(27010-22)	(27010-3)
		Med asfalt	50 m	(27010/1)	–	(27010-3/1)
Tagfod 12 90 x 100 mm		Uden asfalt	50 m	(27090)	(27090-22)	(27090-3)
		Med asfalt	50 m	(27090/1)	–	(27090-3/1)
Tagfod / murafdækning 12 A		Uden asfalt	100 m	(27003)	(27003-22)	(27003-3)
		Med asfalt	100 m	(27003/1)	–	–
Tagfod / murafdækning 12 B		Uden asfalt	100 m	(27002)	(27002-22)	(27002-3)
		Med asfalt	100 m	(27002/1)	–	–

JUAL VINDSKEDE	TEGNING (alle mål i mm)		ANTAL (pr. kolli)	0,6 mm alu. vejrbest. (varenummer)	0,6 mm alu. sortlakeret (varenummer)	0,65 mm zink 12 (varenummer)
Vindskede 18 (ikke klippet)		Uden asfalt	50 m	(40501)	(40501-22)	(40501-3)
		Med asfalt	50 m	(40501/1)	–	(40501-3/1)
Vindskede 18 (klippet) Højre eller venstre		Med asfalt	50 m	(40501/1H)	–	–
		Med asfalt	50 m	(40501/1V)	–	–
Vindskede 18 100 mm flange (ikke klippet)		Uden asfalt	50 m	(40510)	(40510-22)	(40510-3)
		Med asfalt	50 m	(40510/1)	–	(40510-3/1)
Vindskede 18 100 mm flange (klippet) Højre eller venstre		Med asfalt	50 m	(40510/1H)	–	–
		Med asfalt	50 m	(40510/1V)	–	–

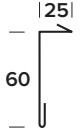
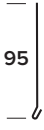

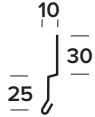
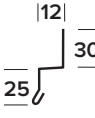
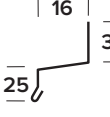
JUAL LØSKANT / VANDNÆSE	TEGNING (alle mål i mm)	ANTAL (pr. kolli)	0,6 mm alu. vejrbest. (varenummer)	0,6 mm alu. sortlakeret (varenummer)	0,65 mm zink 12 (varenummer)
Løskant 15	 L = 1000 mm	100 m	(36001)	(36001-22)	(36001-3)
Vandnæse 3	 L = 1000 mm		(6001)	(6001-22)	(6001-3)

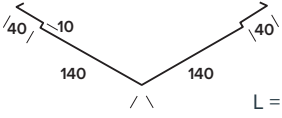
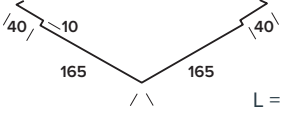
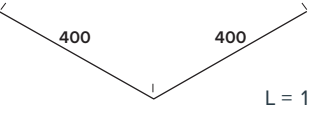
PLADESAMLER	TEGNING (alle mål i mm)	ANTAL (pr. kolli)	0,6 mm alu. vejrbest. (varenummer)	0,6 mm alu. sortlakeret (varenummer)	0,65 mm zink 12 (varenummer)
Pladesamler 19 vandnæse til 10 mm plade	 L = 1000 mm	100 m	(43501)	(43501-22)	(43501-3)
Pladesamler 19 A vandnæse til 12 mm plade	 L = 1000 mm		(43502)	(43502-22)	(43502-3)
Pladesamler 19 B vandnæse til 16 mm plade	 L = 1000 mm		(43503)	(43503-22)	(43503-3)



JUAL SKOTRENDE	TEGNING (alle mål i mm)	ANTAL (pr. kolli)	0,6 mm alu. vejrbest. (varenummer)	0,6 mm alu. sortlakeret (varenummer)	0,65 mm zink 12 (varenummer)
6" dobbelt 21 A skotrende	 L = 1000 mm	25 m	(47001)	(47001-22)	(47001-3)
7" dobbelt 21 B skotrende	 L = 1000 mm		(47002)	(47002-22)	(47002-3)
16" skotrende	 L = 1000 mm		(47016)	(47016-22)	(47016-3)
Dobbelt blindfals til skotrende	 L = 1000 mm	25 stk.	(48600)	(48600-22)	(48600-3)



**SPECIALOPGAVER ER STANDARD FOR JUAL**  
VI ER SPECIALISEREDE I AT TILPASSE  
PRODUKTER OG UDVIKLE LØSNINGER,  
DER MATCHER DINE ØNSKER  
- STADIG MED KORT LEVERINGSTID

**CE** CE-mærket i henhold til DS/EN-14783

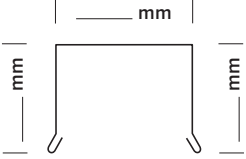
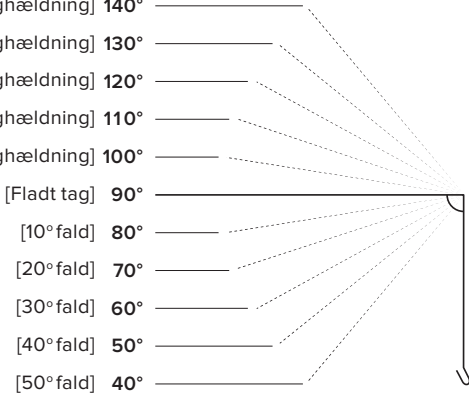
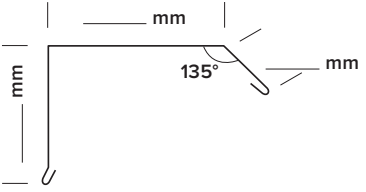
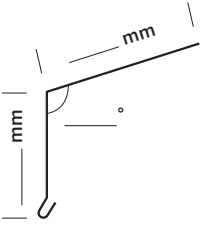
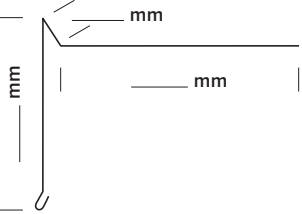



# BYGNINGSPROFILER PÅ SPECIALMÅL [BESTILLING]

<p>KAPSEL TYPE 5</p> 	<p>ILLUSTRATION AF VINKLER</p> <p>[50° taghældning] 140°          [40° taghældning] 130°          [30° taghældning] 120°          [20° taghældning] 110°          [10° taghældning] 100°          [Fladt tag] 90°          [10° fald] 80°          [20° fald] 70°          [30° fald] 60°          [40° fald] 50°          [50° fald] 40°</p> 
<p>KAPSEL TYPE 9</p> 	<p>TEGNING</p> <p>Angiv venligst alle mål i mm          Husk at angive nødvendige vinkler</p>
<p>TAGFOD TYPE 12</p> 	<p>Længde pr. stk. (mm): _____</p> <p>Antal (stk.): _____</p> <p>Materiale: _____</p> <p>Materialetykkelse (mm): _____</p> <p>Ordre <input type="checkbox"/> Prisforespørgsel <input type="checkbox"/></p> <p>Evt. bemærkninger: _____</p>
<p>VINDSKEDE TYPE 18</p> 	
<p>LØSKANT TYPE 15</p> 	

Send din bestilling på mail til [jual@jual.dk](mailto:jual@jual.dk) – eller via fax på 75 69 37 37.

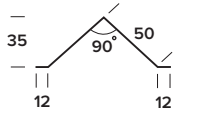
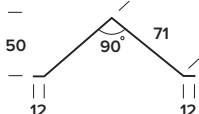
KONTAKTPERSON: \_\_\_\_\_ MOBIL: \_\_\_\_\_

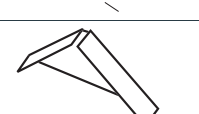
FIRMANAVN: \_\_\_\_\_

JUAL STÅL- TREKANTLISTE	TEGNING (alle mål i mm)	ANTAL (pr. kolli)	MATERIALE	(varenummer)
Ståltrekantliste Model 50	 L = 2000 mm	50 m	0,5 mm galv. stål	(90790-50)
Ståltrekantliste Model 71	 L = 2000 mm	30 m	0,5 mm galv. stål	(90790-71)
Afvalmet endebund til model 50	 L = 90 mm	25 stk.	0,5 mm galv. stål	90790-50A)
Afvalmet endebund til model 71	 L = 100 mm	25 stk.	0,5 mm galv. stål	(90790-71A)
Flad endebund til model 50	 30	25 stk.	Sort plastisol	(90790-50F)
Flad endebund til model 71	 30	25 stk.	Sort plastisol	(90790-71F)

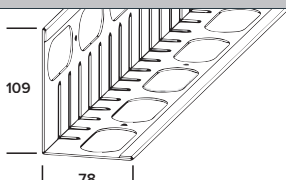
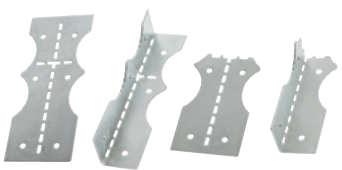
JUAL DRÆNPROFIL	TEGNING (alle mål i mm)	ANTAL (pr. kolli)	MATERIALE	(varenummer)
Vendbar drænprofil til grønne tage	 L = 2500 mm	10 stk.	1,0 mm syrefast rustfrit stål  1,5 mm søvands- bestandigt aluminium	(30000R)  (30000A)
Universalbeslag til JUAL drænprofiler	 Anvendes til langs- gående samlinger og hjørnesamlinger af drænprofiler	Efter ordre	1,0 mm syrefast rustfrit stål  1,5 mm søvands- bestandigt aluminium	(30001R)  (30001A)



DRÆNPROFILER  
SAMLES MED  
UNIVERSALBESLAG



# 14 FARVER PÅ LAGER TIL ALUMINIUMSPROFILER

Vælger du en af JUAL's 14 standardfarver, kan du forvente lynhurtig levering af bygningsprofiler.

Ønsker du andre farver, leverer vi pulverlakerede bygningsprofiler i præcis de farver, du har brug for.

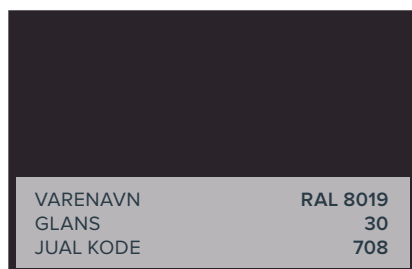
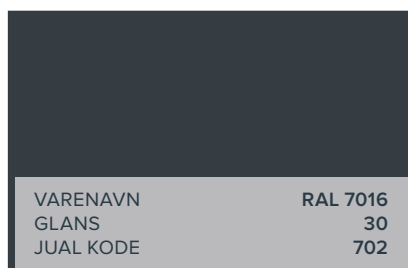
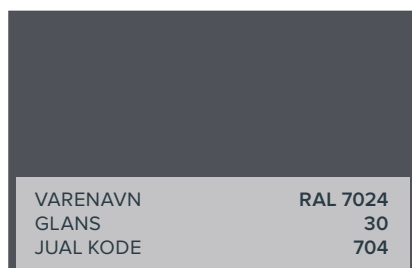
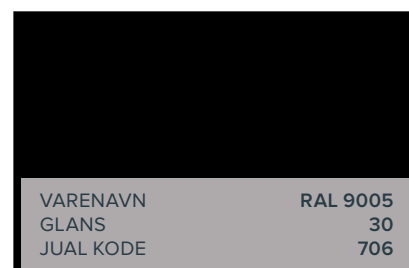
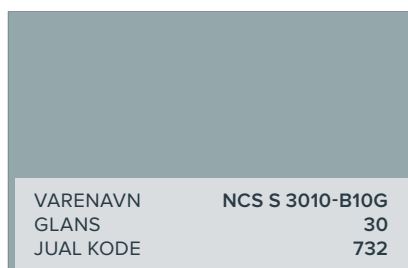
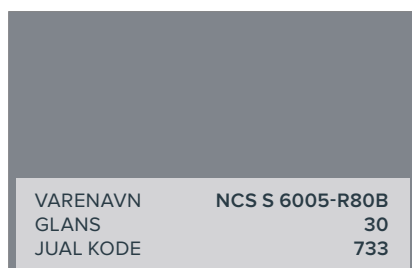
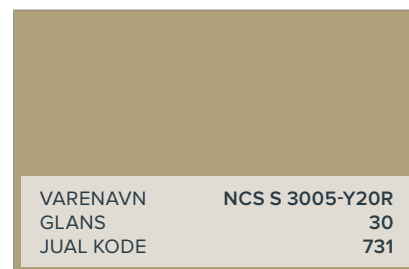
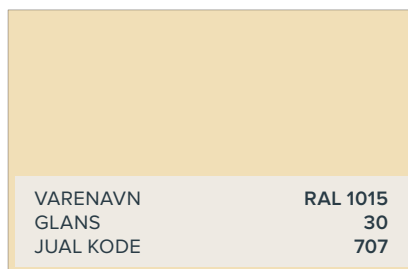
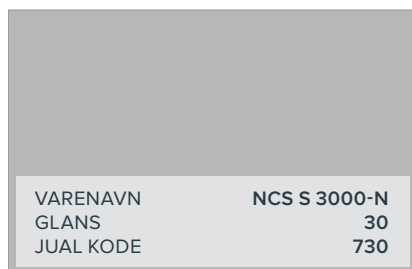
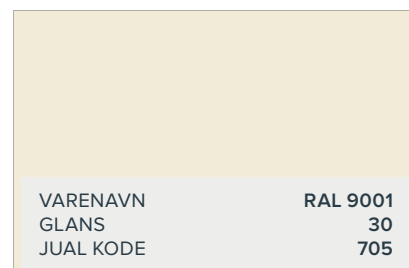
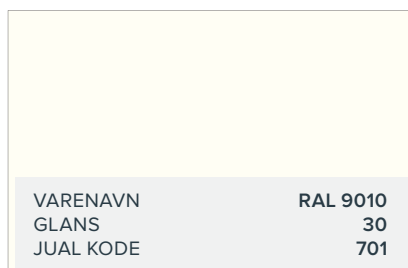
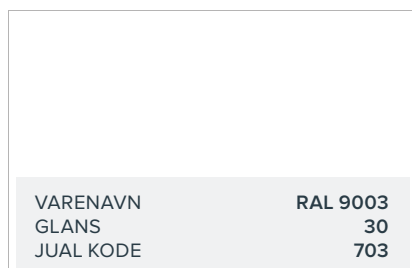

DU ER ALTID  
VELKOMMEN TIL  
AT REKVIRERE  
EN FARVEPRØVE

Der tages forbehold for farvegengivelsen.

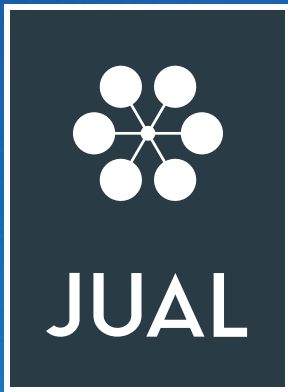

## SPECIALOPGAVER ER STANDARD FOR JUAL

VI ER SPECIALISEREDE I AT  
TILPASSE PRODUKTER,  
DER MATCHER DINE ØNSKER

# BESTEMMELSE AF HJØRNEKLIP

## NORMAL

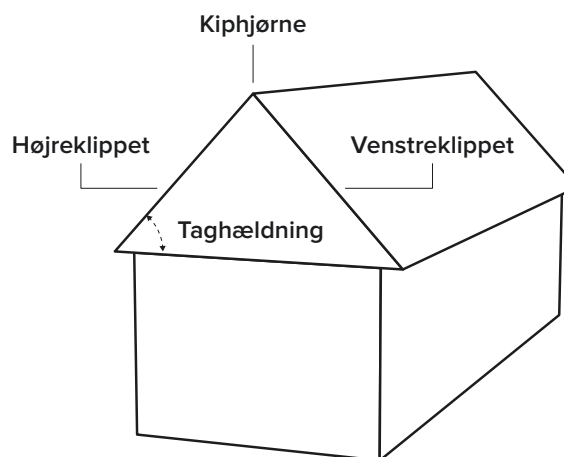

## EN-SIDET

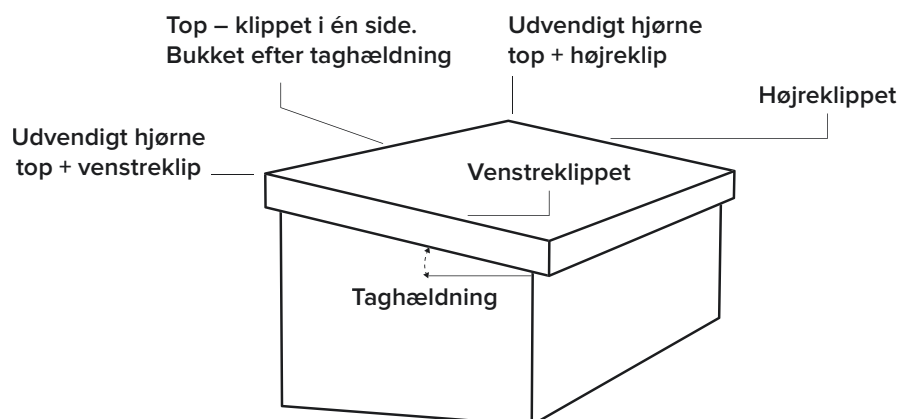

## FLADT

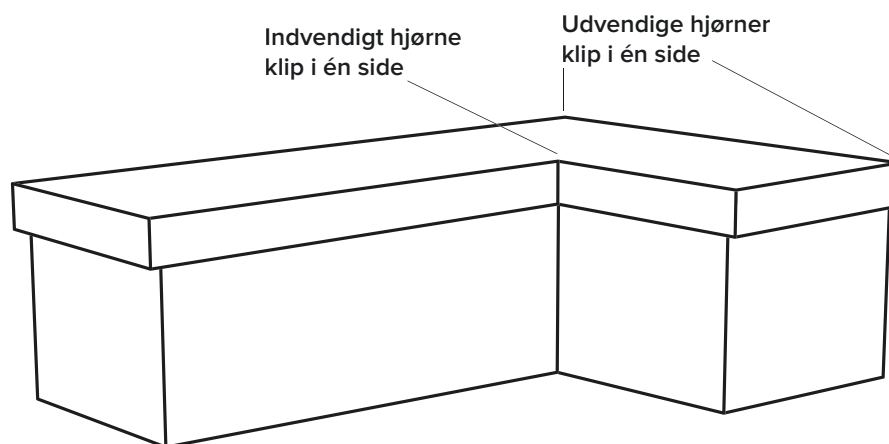

# STERN MED BLINDFALS

## [BESTILLING]

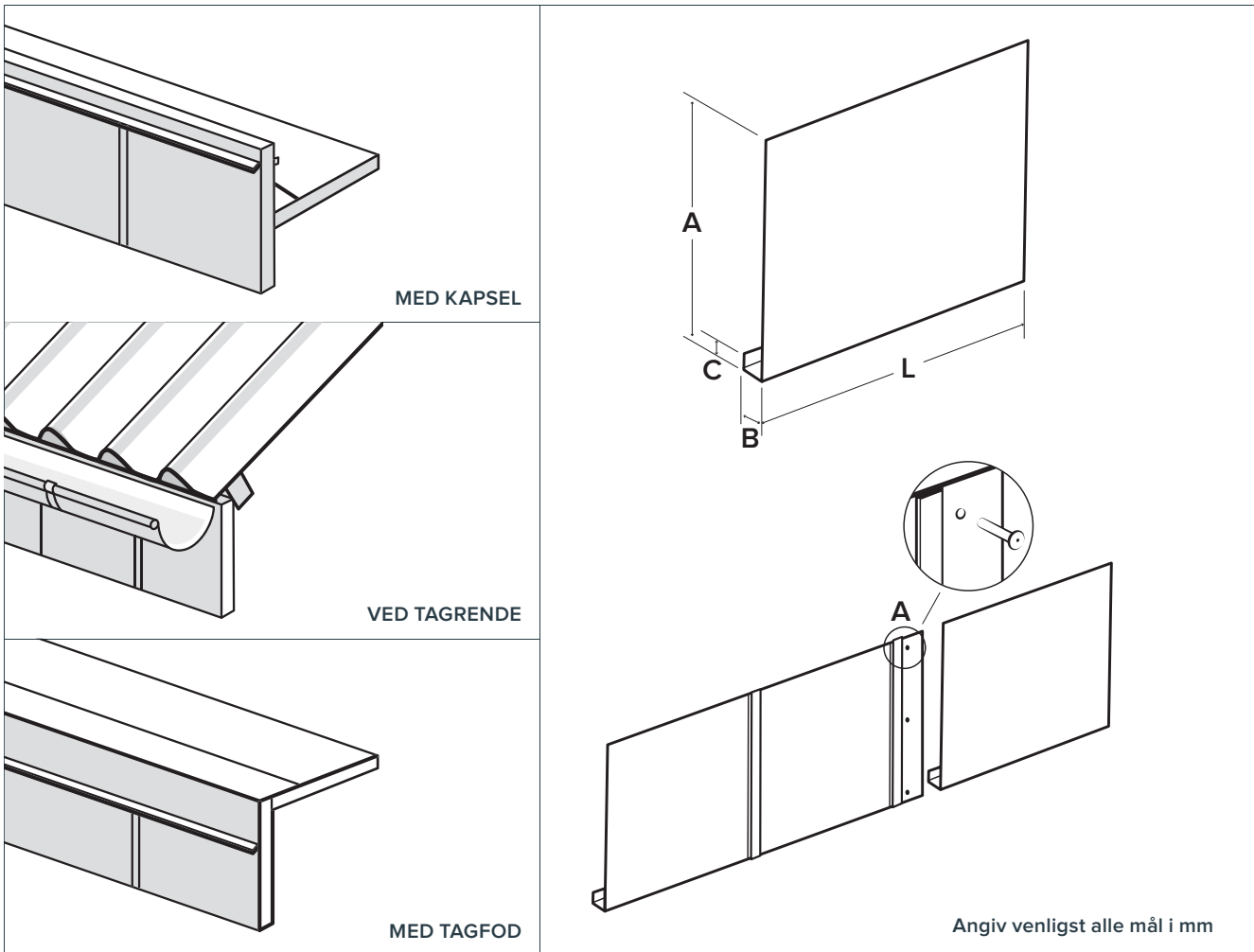

Materiale: \_\_\_\_\_

A-mål (mm): \_\_\_\_\_

B-mål (mm): \_\_\_\_\_

C-mål (mm): \_\_\_\_\_

Antal (stk.): \_\_\_\_\_

Længde 500 mm (dækbredde 460 mm)

Længde 1000 mm (dækbredde 960 mm)

Ordre  Prisforespørgsel

Evt. bemærkninger: \_\_\_\_\_

\_\_\_\_\_

Send din bestilling på mail til [jual@jual.dk](mailto:jual@jual.dk) – eller via fax på 75 69 37 37.

KONTAKTPERSON: \_\_\_\_\_ MOBIL: \_\_\_\_\_

FIRMANAVN: \_\_\_\_\_

# AFVANDING

JUAL TAGBRØND	ANTAL (pr. kolli)	RØR diameter (udvendig)	ANVENDELSE	250 MM RØR (varenummer)	400 MM RØR (varenummer)	600 MM RØR (varenummer)
<b>Tagbrønd i rustfrit stål med tagpap</b>  <b>MATERIALEVALG:</b> SBS: (-101) APP: (-114)    	10 stk.	Ø 50 mm	Ø 50 mm muffe Ø 63 mm indstik	(60050-250-1xx)	(60050-400-1xx)	(60050-600-1xx)
		Ø 63 mm	Ø 75 mm indstik	(60063-250-1xx)	(60063-400-1xx)	(60063-600-1xx)
		Ø 75 mm	Ø 75 mm muffe Ø 90 mm indstik	(60075-250-1xx)	(60075-400-1xx)	(60075-600-1xx)
		Ø 90 mm	Ø 90 mm muffe Ø 110 mm indstik	(60090-250-1xx)	(60090-400-1xx)	(60090-600-1xx)
		Ø 110 mm	Ø 110 mm muffe Ø 125 mm indstik	(60110-250-1xx)	(60110-400-1xx)	(60110-600-1xx)
		Ø 125 mm	Ø 125 mm muffe Ø 145 mm indstik	(60125-250-1xx)	(60125-400-1xx)	(60125-600-1xx)
		Ø 145 mm	Ø 160 mm indstik	(60145-250-1xx)	(60145-400-1xx)	(60145-600-1xx)
		Ø 160 mm	Ø 160 mm muffe	(60160-250-1xx)	(60160-400-1xx)	(60160-600-1xx)
<b>Tagbrønd i rustfrit stål med Derbigum tagpap</b>    	10 stk.	Ø 50 mm	Ø 50 mm muffe Ø 63 mm indstik	(60050-250-103)	(60050-400-103)	(60050-600-103)
		Ø 63 mm	Ø 75 mm indstik	(60063-250-103)	(60063-400-103)	(60063-600-103)
		Ø 75 mm	Ø 75 mm muffe Ø 90 mm indstik	(60075-250-103)	(60075-400-103)	(60075-600-103)
		Ø 90 mm	Ø 90 mm muffe Ø 110 mm indstik	(60090-250-103)	(60090-400-103)	(60090-600-103)
		Ø 110 mm	Ø 110 mm muffe Ø 125 mm indstik	(60110-250-103)	(60110-400-103)	(60110-600-103)
		Ø 125 mm	Ø 125 mm muffe Ø 145 mm indstik	(60125-250-103)	(60125-400-103)	(60125-600-103)
		Ø 145 mm	Ø 160 mm indstik	(60145-250-103)	(60145-400-103)	(60145-600-103)
		Ø 160 mm	Ø 160 mm muffe	(60160-250-103)	(60160-400-103)	(60160-600-103)

Husk at bestille bladfang separat. Du finder dem på side 34-35.

Alle tagbrønde leveres med O-ring for indstiksmontage og affaset ende for muffemontage.

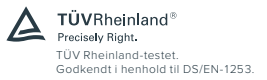

JUAL TAGBRØND	ANTAL (pr. kolli)	RØR diameter (udvendig)	ANVENDELSE	250 MM RØR (varenummer)	400 MM RØR (varenummer)	600 MM RØR (varenummer)
<b>Tagbrønd i rustfrit stål med tagfolie</b>  (Se skema for folietyper herunder)    	10 stk.	Ø 50 mm	Ø 50 mm muffe Ø 63 mm indstik	(60050-250-2xx)	(60050-400-2xx)	(60050-600-2xx)
		Ø 63 mm	Ø 75 mm indstik	(60063-250-2xx)	(60063-400-2xx)	(60063-600-2xx)
		Ø 75 mm	Ø 75 mm muffe Ø 90 mm indstik	(60075-250-2xx)	(60075-400-2xx)	(60075-600-2xx)
		Ø 90 mm	Ø 90 mm muffe Ø 110 mm indstik	(60090-250-2xx)	(60090-400-2xx)	(60090-600-2xx)
		Ø 110 mm	Ø 110 mm muffe Ø 125 mm indstik	(60110-250-2xx)	(60110-400-2xx)	(60110-600-2xx)
		Ø 125 mm	Ø 125 mm muffe Ø 145 mm indstik	(60125-250-2xx)	(60125-400-2xx)	(60125-600-2xx)
		Ø 145 mm	Ø 160 mm indstik	(60145-250-2xx)	(60145-400-2xx)	(60145-600-2xx)
		Ø 160 mm	Ø 160 mm muffe	(60160-250-2xx)	(60160-400-2xx)	(60160-600-2xx)

Husk at bestille bladfang separat. Du finder dem på side 34-35.

Alle tagbrønde leveres med O-ring for indstiksmontage og affaset ende for muffemontage.

## Har du brug for vejledning om valg af tagbrønde?

Kontakt os på 76 83 11 33 eller [jual@jual.dk](mailto:jual@jual.dk)

JUAL FOLIETYPE	FABRIKAT	FARVE	MEMBRAN-KODE
Bestilles med følgende membrankoder	Alkorplan PVC Alkorplan PVC	Mørk grå Lys grå	(-201) (-202)
	Protan PVC Protan PVC	Mørk grå Lys grå	(-203) (-204)
	Sikaplan PVC Sikaplan PVC Sarnafil T - TPO	Mørk grå Lys grå Lys grå	(-206) (-207) (-208)
	Super Seal Thermobond EPDM	Sort	(-211)
	Termoplan T	Beige	(-217)
	Kundefolie (Folie leveres af kunden)	-	(-299)

Ønsker du **andre folietyper**, kan du altid kontakte os.

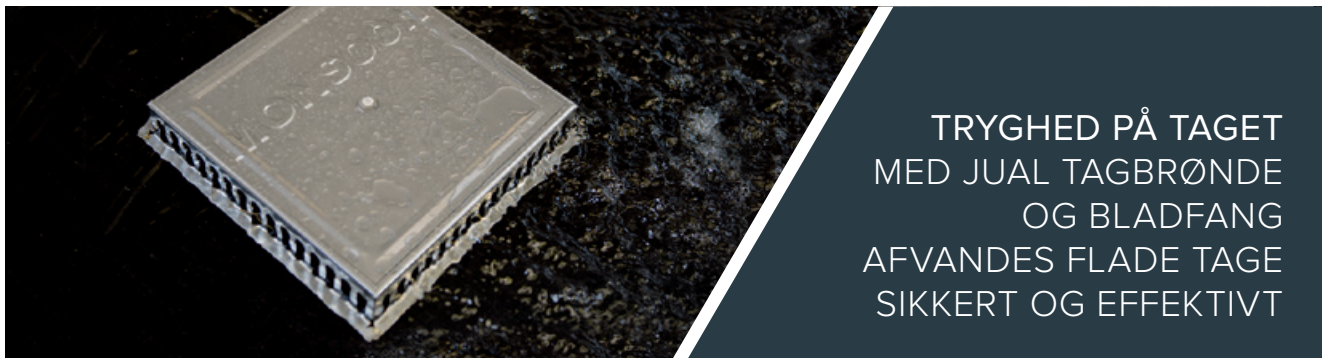

TRYGHED PÅ TAGET  
MED JUAL TAGBRØNDE  
OG BLADFANG  
AFVANDES FLADE TAGE  
SIKKERT OG EFFEKTIVT

JUAL TAGBRØND	ANTAL (pr. kolli)	RØR diameter (udvendig)	ANVENDELSE	250 MM RØR (varenummer)	400 MM RØR (varenummer)	600 MM RØR (varenummer)
Tagbrønd med rustfri stålflange  	10 stk.	Ø 50 mm	Ø 50 mm muffe Ø 63 mm indstik	(60050-250-190)	(60050-400-190)	(60050-600-190)
		Ø 63 mm	Ø 75 mm indstik	(60063-250-190)	(60063-400-190)	(60063-600-190)
		Ø 75 mm	Ø 75 mm muffe Ø 90 mm indstik	(60075-250-190)	(60075-400-190)	(60075-600-190)
		Ø 90 mm	Ø 90 mm muffe Ø 110 mm indstik	(60090-250-190)	(60090-400-190)	(60090-600-190)
		Ø 110 mm	Ø 110 mm muffe Ø 125 mm indstik	(60110-250-190)	(60110-400-190)	(60110-600-190)
		Ø 125 mm	Ø 125 mm muffe Ø 145 mm indstik	(60125-250-190)	(60125-400-190)	(60125-600-190)
		Ø 145 mm	Ø 160 mm indstik	(60145-250-190)	(60145-400-190)	(60145-600-190)
		Ø 160 mm	Ø 160 mm muffe	(60160-250-190)	(60160-400-190)	(60160-600-190)

**TÜVRheinland®**  
 Precisely Right.  
 TÜV Rheinland-testet.  
 Godkendt i henhold til DS/EN-1253.

JUAL FLEX TAGBRØND	ANTAL (pr. kolli)	RØR diameter (udvendig)	ANVENDELSE	250 MM RØR (varenummer)	400 MM RØR (varenummer)	600 MM RØR (varenummer)
Flex Tagbrønd med tagpap og fleksibel rustfri stålflange  	10 stk.	Ø 50 mm	Ø 50 mm muffe Ø 63 mm indstik	(60050-250-180)	(60050-400-180)	(60050-600-180)
		Ø 63 mm	Ø 75 mm indstik	(60063-250-180)	(60063-400-180)	(60063-600-180)
		Ø 75 mm	Ø 75 mm muffe Ø 90 mm indstik	(60075-250-180)	(60075-400-180)	(60075-600-180)
		Ø 90 mm	Ø 90 mm muffe Ø 110 mm indstik	(60090-250-180)	(60090-400-180)	(60090-600-180)
		Ø 110 mm	Ø 110 mm muffe Ø 125 mm indstik	(60110-250-180)	(60110-400-180)	(60110-600-180)

Husk at bestille bladfang separat. Du finder dem på side 34-35.

Alle tagbrønde leveres med O-ring for indstiksmontage og affaset ende for muffemontage.

JUAL VERTIKAL SKÅLBRØND	ANTAL (pr. kolli)	DIMENSION	ANVENDELSE	(varenummer)
Vertikal Skålbønd i rustfrit stål med tagpap  <b>MATERIALEVALG:</b> SBS: (-101) APP: (-114) 	Efter ordre	Ø 50x400	Ø 50 mm muffe Ø 63 mm indstik	(6008050-400-1xx)
		Ø 63x400	Ø 75 mm indstik	(6008063-400-1xx)
		Ø 75x400	Ø 75 mm muffe Ø 90 mm indstik	(6008075-400-1xx)
		Ø 90x400	Ø 90 mm muffe Ø 110 mm indstik	(6008090-400-1xx)
		Ø 110x400	Ø 110 mm muffe Ø 125 mm indstik	(6008110-400-1xx)
Vertikal Skålbønd i rustfrit stål med Derbigum 		Ø 50x400	Ø 50 mm muffe Ø 63 mm indstik	(6008050-400-103)
		Ø 63x400	Ø 75 mm indstik	(6008063-400-103)
		Ø 75x400	Ø 75 mm muffe Ø 90 mm indstik	(6008075-400-103)
		Ø 90x400	Ø 90 mm muffe Ø 110 mm indstik	(6008090-400-103)
		Ø 110x400	Ø 110 mm muffe Ø 125 mm indstik	(6008110-400-103)
Vertikal Skålbønd i rustfrit stål med folie* 	Ø 50x400	Ø 50 mm muffe Ø 63 mm indstik	(6008050-400-2xx)	
	Ø 63x400	Ø 75 mm indstik	(6008063-400-2xx)	
	Ø 75x400	Ø 75 mm muffe Ø 90 mm indstik	(6008075-400-2xx)	
	Ø 90x400	Ø 90 mm muffe Ø 110 mm indstik	(6008090-400-2xx)	
	Ø 110x400	Ø 110 mm muffe Ø 125 mm indstik	(6008110-400-2xx)	



\*) Se skema på side 19 for folier.

Husk at bestille bladfang separat. Du finder dem på side 34-35.

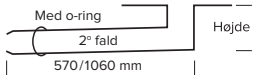
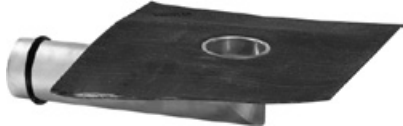
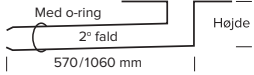
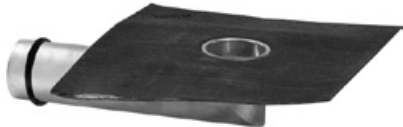
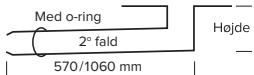
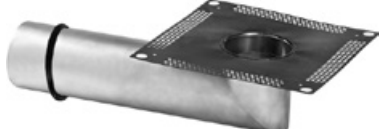
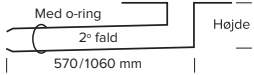
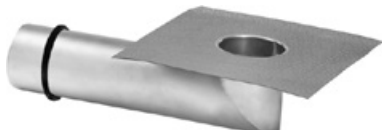

Alle tagbrønde leveres med O-ring for indstiksmontage og affaset ende for muffemontage.

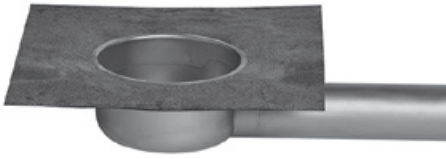
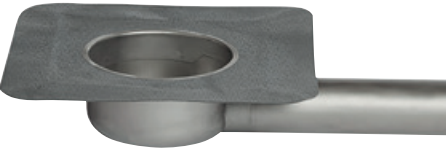

JUAL VINKEL TAGBRØND	ANTAL (pr. kolli)	RØR diameter (udvendig)	HØJDE	570 MM RØR (varenummer)	1060 MM RØR (varenummer)
<b>Vinkel Tagbrønd i rustfrit stål med tagpap</b>  <b>MATERIALEVALG:</b> SBS: (-101) APP: (-114)	Efter ordre	Ø 50 mm	75 mm	(64050-570-1xx)	(64050-1060-1xx)
		Ø 63 mm	88 mm	(64063-570-1xx)	(64063-1060-1xx)
		Ø 75 mm	100 mm	(64075-570-1xx)	(64075-1060-1xx)
		Ø 90 mm	115 mm	(64090-570-1xx)	(64090-1060-1xx)
		Ø 110 mm	135 mm	(64110-570-1xx)	(64110-1060-1xx)
<b>Vinkel Tagbrønd i rustfrit stål med Derbigum tagpap</b>		Ø 50 mm	75 mm	(64050-570-103)	(64050-1060-103)
		Ø 63 mm	88 mm	(64063-570-103)	(64063-1060-103)
		Ø 75 mm	100 mm	(64075-570-103)	(64075-1060-103)
		Ø 90 mm	115 mm	(64090-570-103)	(64090-1060-103)
		Ø 110 mm	135 mm	(64110-570-103)	(64110-1060-103)
<b>Vinkel Tagbrønd i rustfrit stål med stålflange</b>		Ø 50 mm	75 mm	(64050-570-190)	(64050-1060-190)
		Ø 63 mm	88 mm	(64063-570-190)	(64063-1060-190)
		Ø 75 mm	100 mm	(64075-570-190)	(64075-1060-190)
		Ø 90 mm	115 mm	(64090-570-190)	(64090-1060-190)
		Ø 110 mm	135 mm	(64110-570-190)	(64110-1060-190)
<b>Vinkel Tagbrønd i rustfrit stål med tagfolie*</b>		Ø 50 mm	75 mm	(64050-570-2xx)	(64050-1060-2xx)
		Ø 63 mm	88 mm	(64063-570-2xx)	(64063-1060-2xx)
		Ø 75 mm	100 mm	(64075-570-2xx)	(64075-1060-2xx)
		Ø 90 mm	115 mm	(64090-570-2xx)	(64090-1060-2xx)
		Ø 110 mm	135 mm	(64110-570-2xx)	(64110-1060-2xx)

\*) Se skema på side 19 for folier.

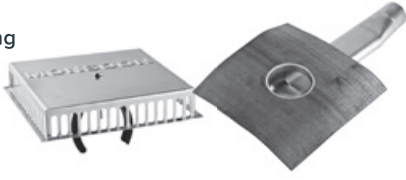
Husk at bestille bladfang separat. Du finder dem på side 34-35.

JUAL VINKEL SKÅLBRØND	ANTAL (pr. kolli)	DIMENSION	(varenummer)
Vinkel Skålbrønd i rustfrit stål  <b>MATERIALEVALG:</b> SBS: (-101) APP: (-114)		Ø 50x600	(6408050-600-1xx)
		Ø 63x600	(6408063-600-1xx)
		Ø 75x600	(6408075-600-1xx)
Vinkel Skålbrønd i rustfrit stål med Derbigum tagpap	Efter ordre	Ø 50x600	(6408050-600-103)
		Ø 63x600	(6408063-600-103)
		Ø 75x600	(6408075-600-103)
Vinkel Skålbrønd i rustfrit stål med tagfolie*		Ø 50x600	(6408050-600-2xx)
		Ø 63x600	(6408063-600-2xx)
		Ø 75x600	(6408075-600-2xx)

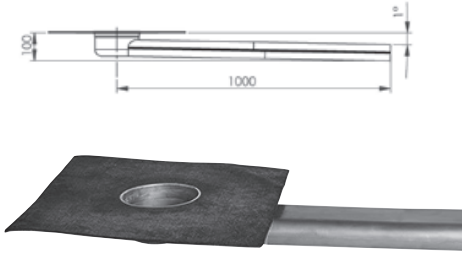
JUAL MURKRONEAFVANDING	ANTAL (pr. kolli)	MEMBRAN	DIMENSION (udvendig)	(varenummer)
Murkroneafvanding i rustfrit stål Horizontal med Monsoon Bladfang     TÜVRheinland® PreciseBy Right. TÜV Rheinland-testet. Godkendt i henhold til DS/EN-1253.	Efter ordre	SBS	Ø 110 mm	(62110-730-101)
		APP	Ø 110 mm	(62110-730-114)
		Derbigum	Ø 110 mm	(62110-730-103)
		Folie*	Ø 110 mm	(62110-730-2xx)

JUAL MURKRONE SKÅLBRØND	ANTAL (pr. kolli)	MEMBRAN	DIMENSION (udvendig)	(varenummer)
Murkrone Skålbrønd i rustfrit stål Lav model  	Efter ordre	SBS	60x140x1000 mm	(6208160-101)
		APP	60x140x1000 mm	(6208160-114)
		Derbigum	60x140x1000 mm	(6208160-103)
		Folie*	60x140x1000 mm	(6208160-2xx)
Vinkelovergang til Murkrone Skålbrønd i rustfrit stål inkl. gummipakning  			90°- Ø 110 mm	(62001)

\*) Se skema på side 19 for folier.

Husk at bestille bladfang separat. Du finder dem på side 34-35.

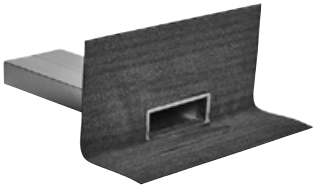
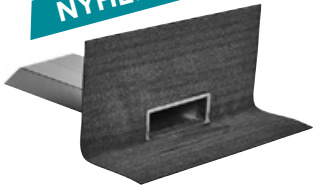

JUAL REKTANGULÆR TAGBRØND	ANTAL (pr. kolli)	DIMENSIONER (BxHxL mm)	LIGE RØRENDE (varenummer)	45° RØRENDE (varenummer)
<b>Rektangulær Tagbrønd med 90° flange. Rustfrit stål og SBS membran</b>  <b>ANVENDELSE:</b> Til afvanding af tagflade gennem murkrone.  <b>MATERIALEVALG:</b> SBS: (-107) APP: (-114)   <b>Med lige rørende</b>   <b>Med 45° rørende</b>	Efter ordre	77 x 56 x 400 mm	(68 077 056 0400-1xx)	(69 077 056 0400-1xx)
		77 x 56 x 600 mm	(68 077 056 0600-1xx)	(69 077 056 0600-1xx)
		95 x 56 x 400 mm	(68 095 056 0400-1xx)	(69 095 056 0400-1xx)
		95 x 56 x 600 mm	(68 095 056 0600-1xx)	(69 095 056 0600-1xx)
		150 x 50 x 400 mm	(68 150 050 0400-1xx)	(69 150 050 0400-1xx)
		150 x 50 x 600 mm	(68 150 050 0600-1xx)	(69 150 050 0600-1xx)
		150 x 50 x 1000 mm	(68 150 050 1000-1xx)	(69 150 050 1000-1xx)
		150 x 100 x 400 mm	(68 150 100 0400-1xx)	(69 150 100 0400-1xx)
		150 x 100 x 600 mm	(68 150 100 0600-1xx)	(69 150 100 0600-1xx)
		150 x 100 x 1000 mm	(68 150 100 1000-1xx)	(69 150 100 1000-1xx)
		200 x 50 x 400 mm	(68 200 050 0400-1xx)	(69 200 050 0400-1xx)
		200 x 50 x 600 mm	(68 200 050 0600-1xx)	(69 200 050 0600-1xx)
		200 x 50 x 1000 mm	(68 200 050 1000-1xx)	(69 200 050 1000-1xx)
		215 x 70 x 400 mm	(68 215 070 0400-1xx)	(69 215 070 0400-1xx)
		215 x 70 x 600 mm	(68 215 070 0600-1xx)	(69 215 070 0600-1xx)
		215 x 70 x 1000 mm	(68 215 070 1000-1xx)	(69 215 070 1000-1xx)
		240 x 50 x 400 mm	(68 240 050 0400-1xx)	(69 240 050 0400-1xx)
		240 x 50 x 600 mm	(68 240 050 0600-1xx)	(69 240 050 0600-1xx)
		240 x 50 x 1000 mm	(68 240 050 1000-1xx)	(69 240 050 1000-1xx)
		300 x 100 x 400 mm	(68 300 100 0400-1xx)	(69 300 100 0400-1xx)
		300 x 100 x 600 mm	(68 300 100 0600-1xx)	(69 300 100 0600-1xx)
		300 x 100 x 1000 mm	(68 300 100 1000-1xx)	(69 300 100 1000-1xx)
		400 x 100 x 400 mm	(68 400 100 0400-1xx)	(69 400 100 0400-1xx)
		400 x 100 x 600 mm	(68 400 100 0600-1xx)	(69 400 100 0600-1xx)
400 x 100 x 1000 mm	(68 400 100 1000-1xx)	(69 400 100 1000-1xx)		
500 x 100 x 400 mm	(68 500 100 0400-1xx)	(69 500 100 0400-1xx)		
500 x 100 x 600 mm	(68 500 100 0600-1xx)	(69 500 100 0600-1xx)		
500 x 100 x 1000 mm	(68 500 100 1000-1xx)	(69 500 100 1000-1xx)		

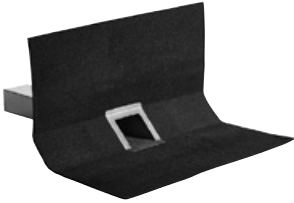
JUAL REKTANGULÆR TAGBRØND	ANTAL (pr. kolti)	DIMENSIONER (BxHxL mm)	LIGE RØRENDE (varenummer)	45° RØRENDE (varenummer)
<b>Rektangulær Tagbrønd til trekantliste</b>  <b>ANVENDELSE:</b> Til afvanding af tagflade gennem murkrone med trekantliste op til 60x60 mm    <b>MATERIALEVALG:</b> SBS: (-107) APP: (-114)	<b>NYHED</b>          Efter ordre	77 x 56 x 400 mm	(70 077 056 0400-1xx)	(71 077 056 0400-1xx)
		77 x 56 x 600 mm	(70 077 056 0600-1xx)	(71 077 056 0600-1xx)
		95 x 56 x 400 mm	(70 095 056 0400-1xx)	(71 095 056 0400-1xx)
		95 x 56 x 600 mm	(70 095 056 0600-1xx)	(71 095 056 0600-1xx)

**NYHED**

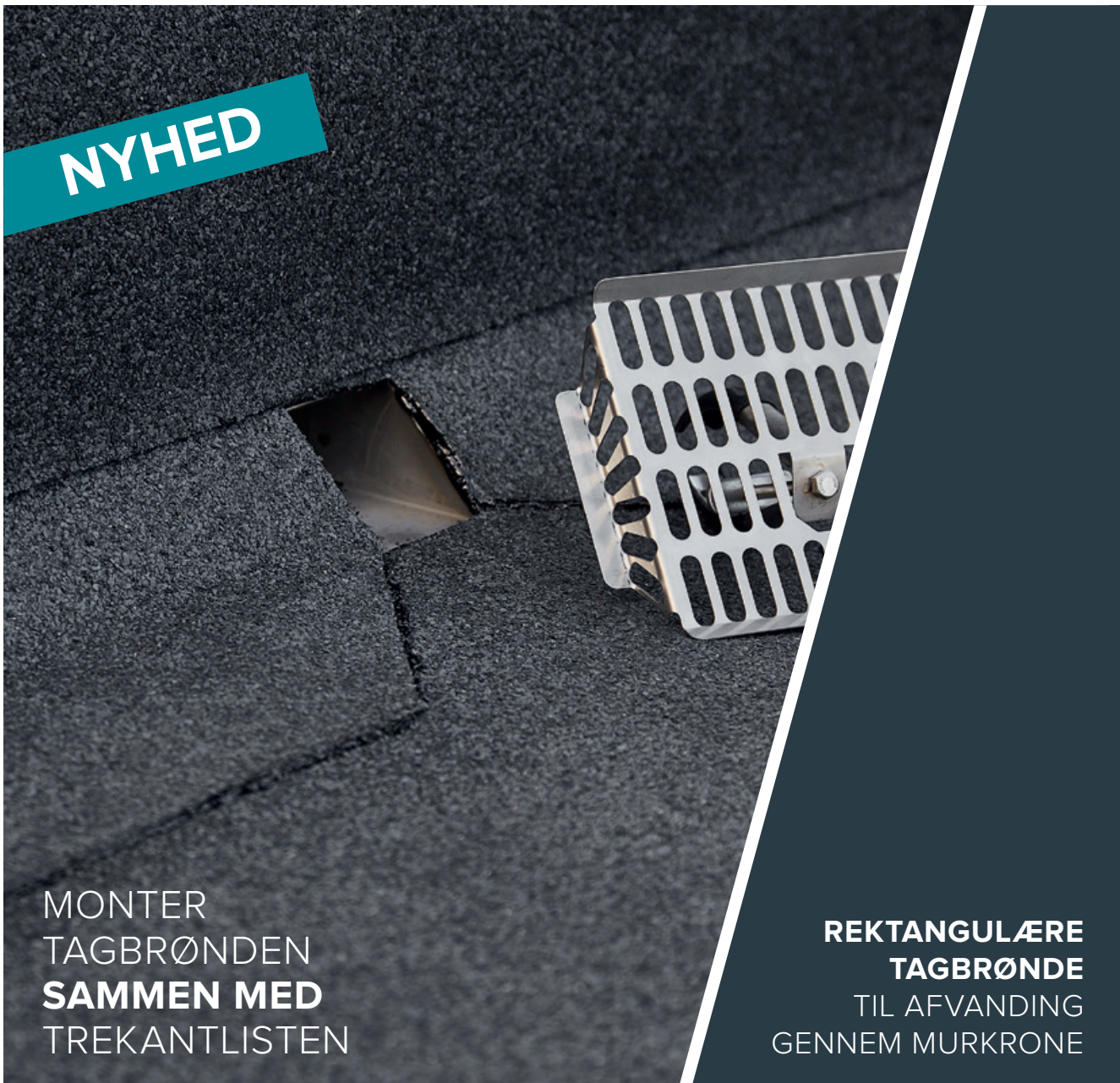

**MONTER  
TAGBRØNDEN  
SAMMEN MED  
TREKANTLISTEN**

**REKTANGULÆRE  
TAGBRØNDE  
TIL AFVANDING  
GENNEM MURKRONE**

JUAL HORIZONTAL TAGBRØND	ANTAL (pr. kolli)	RØR diameter (udvendig)	INDLØB	400 MM RØR (varenummer)	600 MM RØR (varenummer)
<b>Horisontal Tagbrønd i rustfrit stål med tagpap</b>  <b>MATERIALEVALG:</b> SBS: (-101) APP: (-114)		Ø 50 mm	40x40 mm	(6101050-400-1xx)	(6101050-600-1xx)
		Ø 75 mm	63x63 mm	(6101075-400-1xx)	(6101075-600-1xx)
		Ø 90 mm	78x78 mm	(6101090-400-1xx)	(6101090-600-1xx)
		Ø 110 mm	95x95 mm	(6101110-400-1xx)	(6101110-600-1xx)
<b>Horisontal Tagbrønd i rustfrit stål med Derbigum tagpap</b>	Efter ordre	Ø 50 mm	40x40 mm	(6101050-400-103)	(6101050-600-103)
		Ø 75 mm	63x63 mm	(6101075-400-103)	(6101075-600-103)
		Ø 90 mm	78x78 mm	(6101090-400-103)	(6101090-600-103)
		Ø 110 mm	95x95 mm	(6101110-400-103)	(6101110-600-103)
<b>Horisontal Tagbrønd i rustfrit stål med tagfolie*</b>		Ø 50 mm	40x40 mm	(6101050-400-2xx)	(6101050-600-2xx)
		Ø 75 mm	63x63 mm	(6101075-400-2xx)	(6101075-600-2xx)
		Ø 90 mm	78x78 mm	(6101090-400-2xx)	(6101090-600-2xx)
		Ø 110 mm	95x95 mm	(6101110-400-2xx)	(6101110-600-2xx)

\*) Se skema på side 19 for folier.

Husk at bestille bladfang separat. Du finder dem på side 34-35.

Alle tagbrønde leveres med O-ring for indstiksmontage og affaset ende for muffemontage.





## HUSK PAPSTYKKET UNDER TAGBRØNDEN!



DEN BEDSTE MONTAGE  
OPNÅS, NÅR DU LÆGGER  
ET STYKKE TAGPAP UNDER  
TAGBRØNDENS STÅLFLANGE



Underpap-stykker  
på 600 x 600 mm i  
SBS og APP kan købes  
med til tagbrønde, fald-  
stammeinddækninger m.m.



Se side 40  
for mere information

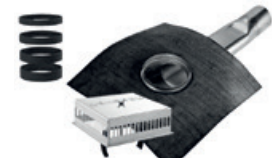

# NØDAFVANDING

JUAL NØDAFVANDING	ANTAL (pr. kollo)	MEMBRAN	RØR diameter (udvendig)	250 MM RØR (varenummer)	400 MM RØR (varenummer)	600 MM RØR (varenummer)
<b>Tagbrønd til nødafvanding inkl. Monsoon Bladfang</b>   <b>TÜVRheinland®</b> Precisely Right. TÜV Rheinland-testet. Godkendt i henhold til DS/EN-1253.	Efter ordre	SBS	Ø 110 mm	(65110-250-101)	(65110-400-101)	(65110-600-101)
		APP	Ø 110 mm	(65110-250-114)	(65110-400-114)	(65110-600-114)
		Derbigum	Ø 110 mm	(65110-250-103)	(65110-400-103)	(65110-600-103)
		Folie*	Ø 110 mm	(65110-250-2xx)	(65110-400-2xx)	(65110-600-2xx)

JUAL NØDAFVANDING HORIZONTAL	ANTAL (pr. kollo)	MEMBRAN	RØR diameter (udvendig)	730 MM RØR (varenummer)
<b>Tagbrønd til nødafvanding inkl. Monsoon Bladfang</b>   <b>TÜVRheinland®</b> Precisely Right. TÜV Rheinland-testet. Godkendt i henhold til DS/EN-1253.	Efter ordre	SBS	Ø 110 mm	(65110-730-101)
		APP	Ø 110 mm	(65110-730-114)
		Derbigum	Ø 110 mm	(65110-730-103)
		Folie*	Ø 110 mm	(65110-730-2xx)

JUAL OPSTUVNINGSRING	ANTAL (pr. kollo)	ANVENDELSE	DIMENSION	(varenummer)
<b>Opstuvningsring EPDM</b> 	5 stk.	Til nødafvanding Kan afskæres i 25-70 mm højde	Ø 50 mm	(1504101)
			Ø 63 mm	(1504102)
			Ø 75 mm	(1504103)
			Ø 90 mm	(1504104)
			Ø 110 mm	(1504105)
			Ø 125 mm	(1504106)
			Ø 145 mm	(1504107)
			Ø 160 mm	(1504108)
<b>Opstuvningsring Rustfrit stål</b> 	5 stk.	Til nødafvanding Vendbar til 25 eller 35 mm	Ø 75 mm, H25/35	(220012-075)
			Ø 90 mm, H25/35	(220012-090)
			Ø 110 mm, H25/35	(220012-110)
			Ø 125 mm, H25/35	(220012-125)
			Ø 160 mm, H25/35	(220012-160)
		Fast højde 50 mm	Ø 110 mm, H50	(220012-50-110)

\*) Se skema på side 19 for folier.

Husk at bestille bladfang separat. Du finder dem på side 34-35.

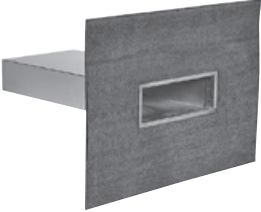
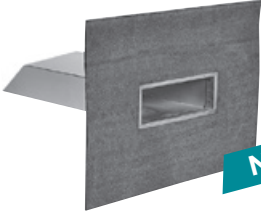

JUAL REKTANGULÆR TAGBRØND	ANTAL (pr. kolli)	DIMENSIONER (BxHxL mm)	LIGE RØRENDE (varenummer)	45° RØRENDE (varenummer)
<p>Rektangulær tagbrønd med plan flange. Rustfrit stål og SBS membran</p> <p><b>ANVENDELSE:</b> Til nødafvanding gennem murkrone</p> <p><b>MATERIALEVALG:</b> SBS: (-107) APP: (-114)</p>  <p>Med lige rørende</p>  <p>Med 45° rørende</p>	<p>Efter ordre</p> <p><b>NYHED</b></p>	77 x 56 x 400 mm	(66 077 056 0400-1xx)	(67 077 056 0400-1xx)
		77 x 56 x 600 mm	(66 077 056 0600-1xx)	(67 077 056 0600-1xx)
		95 x 56 x 400 mm	(66 095 056 0400-1xx)	(67 095 056 0400-1xx)
		95 x 56 x 600 mm	(66 095 056 0600-1xx)	(67 095 056 0600-1xx)
		150 x 50 x 400 mm	(66 150 050 0400-1xx)	(67 150 050 0400-1xx)
		150 x 50 x 600 mm	(66 150 050 0600-1xx)	(67 150 050 0600-1xx)
		150 x 50 x 1000 mm	(66 150 050 1000-1xx)	(67 150 050 1000-1xx)
		150 x 100 x 400 mm	(66 150 100 0400-1xx)	(67 150 100 0400-1xx)
		150 x 100 x 600 mm	(66 150 100 0600-1xx)	(67 150 100 0600-1xx)
		150 x 100 x 1000 mm	(66 150 100 1000-1xx)	(67 150 100 1000-1xx)
		200 x 50 x 400 mm	(66 200 050 0400-1xx)	(67 200 050 0400-1xx)
		200 x 50 x 600 mm	(66 200 050 0600-1xx)	(67 200 050 0600-1xx)
		200 x 50 x 1000 mm	(66 200 050 1000-1xx)	(67 200 050 1000-1xx)
		215 x 70 x 400 mm	(66 215 070 0400-1xx)	(67 215 070 0400-1xx)
		215 x 70 x 600 mm	(66 215 070 0600-1xx)	(67 215 070 0600-1xx)
		215 x 70 x 1000 mm	(66 215 070 1000-1xx)	(67 215 070 1000-1xx)
		240 x 50 x 400 mm	(66 240 050 0400-1xx)	(67 240 050 0400-1xx)
		240 x 50 x 600 mm	(66 240 050 0600-1xx)	(67 240 050 0600-1xx)
		240 x 50 x 1000 mm	(66 240 050 1000-1xx)	(67 240 050 1000-1xx)
		300 x 100 x 400 mm	(66 300 100 0400-1xx)	(67 300 100 0400-1xx)
		300 x 100 x 600 mm	(66 300 100 0600-1xx)	(67 300 100 0600-1xx)
		300 x 100 x 1000 mm	(66 300 100 1000-1xx)	(67 300 100 1000-1xx)
		400 x 100 x 400 mm	(66 400 100 0400-1xx)	(67 400 100 0400-1xx)
		400 x 100 x 600 mm	(66 400 100 0600-1xx)	(67 400 100 0600-1xx)
400 x 100 x 1000 mm	(66 400 100 1000-1xx)	(67 400 100 1000-1xx)		
500 x 100 x 400 mm	(66 500 100 0400-1xx)	(67 500 100 0400-1xx)		
500 x 100 x 600 mm	(66 500 100 0600-1xx)	(67 500 100 0600-1xx)		
500 x 100 x 1000 mm	(66 500 100 1000-1xx)	(67 500 100 1000-1xx)		

NYHED

AFVANDING



**JUAL**

ROOFER'S CHOICE



# DAMPSPÆRRE PRODUKTER

**NYHED**

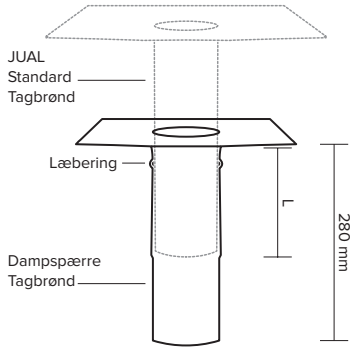
JUAL DAMPSPÆRRE TAGBRØND	ANTAL (pr. kolli)	MEMBRAN	RØR diameter (udvendig)	Muffelængde L = 105 mm	Muffelængde L = 205 mm
<p>Dampspærre Tagbrønd i rustfrit stål</p>   <p>JUAL Standard Tagbrønd</p> <p>Læbering</p> <p>Dampspærre Tagbrønd</p> <p>280 mm</p> <p><b>TÜVRheinland®</b> Precisely Right. TUV Rheinland-testet. Godkendt i henhold til DS/EN-1253.</p>	1 stk.	<b>MATERIALEVALG:</b> SBS: (-101) APP: (-114)	Ø 75 mm	(63075-280S-1xx)	(63075-280-1xx)
			Ø 110 mm	(63110-280S-1xx)	(63110-280-1xx)
			Ø 125 mm	(63125-280S-1xx)	(63125-280-1xx)
			Ø 160 mm	(63160-280S-1xx)	(63160-280-1xx)
		Derbigum	Ø 75 mm	(63075-280S-103)	(63075-280-103)
			Ø 110 mm	(63110-280S-103)	(63110-280-103)
			Ø 125 mm	(63125-280S-103)	(63125-280-103)
			Ø 160 mm	(63160-280S-103)	(63160-280-103)
		Stål	Ø 75 mm	(63075-280S-190)	(63075-280-190)
			Ø 110 mm	(63110-280S-190)	(63110-280-190)
			Ø 125 mm	(63125-280S-190)	(63125-280-190)
			Ø 160 mm	(63160-280S-190)	(63160-280-190)
Folie*	Ø 75 mm	(63075-280S-2xx)	(63075-280-2xx)		
	Ø 110 mm	(63110-280S-2xx)	(63110-280-2xx)		
	Ø 125 mm	(63125-280S-2xx)	(63125-280-2xx)		
	Ø 160 mm	(63160-280S-2xx)	(63160-280-2xx)		

\*) Se skema på side 19 for folier. Husk at bestille bladfang separat. Du finder dem på side 34-35.

JUAL DAMPSPÆRREPLADE	ANTAL (pr. kolli)	BEMÆRKNINGER	TYPE	(varenummer)
<p>Dampspærreplade</p> 	Efter ordre	Anvendes for at opnå lufttæthed, hvor rør gennembryder dampspærren	Til rør Ø 50 mm	(75050)
			Til rør Ø 63 mm	(75063)
			Til rør Ø 75 mm	(75075)
			Til rør Ø 90 mm	(75090)
			Til rør Ø 110 mm	(75110)
			Til rør Ø 125 mm	(75125)
			Til rør Ø 145 mm	(75145)
			Til rør Ø 160 mm	(75160)
			Til rør Ø efter ordre	(75010)

# JUAL SPECIFIKATION TIL MUFFE- OG INDSTIKSBRØND

## TAGBRØND

### MONTERET I STANDARDRØR MED MUFFE

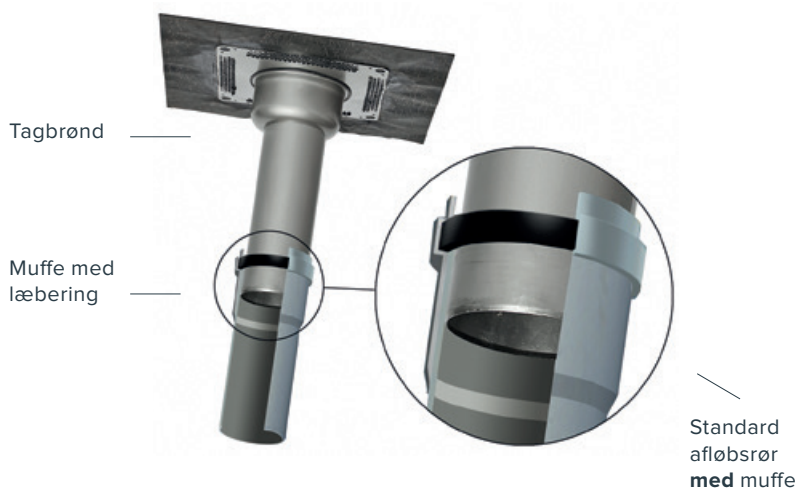

## TAGBRØND

### MONTERET MED O-RING I STANDARDRØR UDEN MUFFE

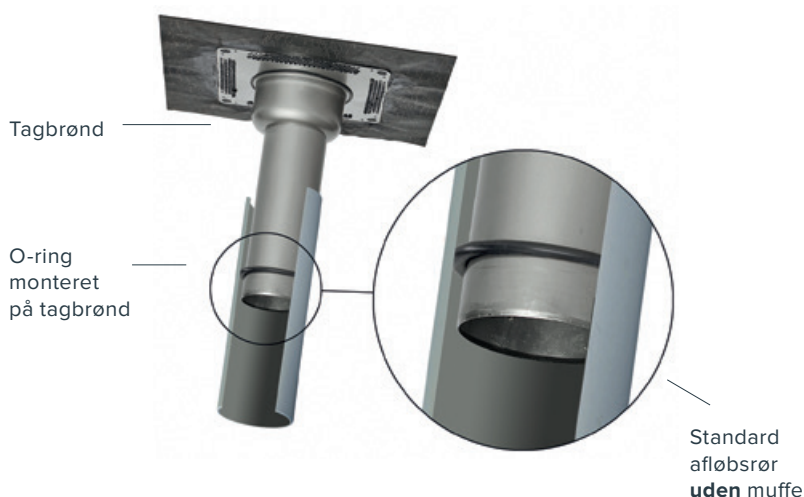

## TAGBRØND

### MONTERET MED OPSTUVNINGSPAKNING I STANDARDRØR UDEN MUFFE

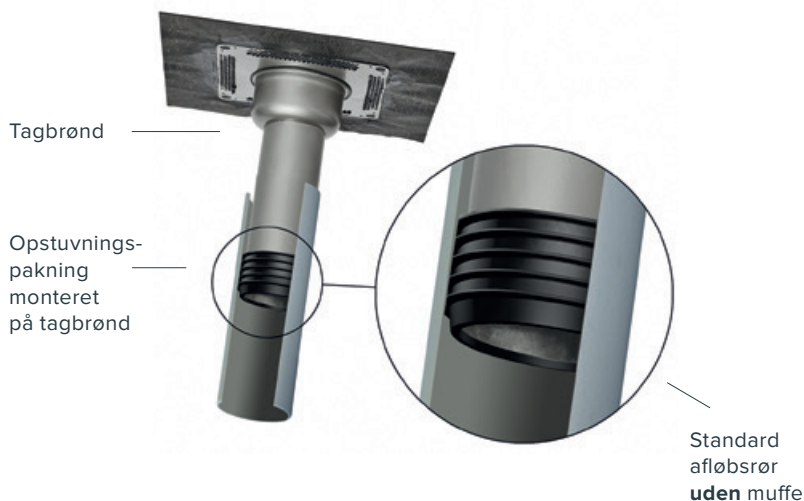



JUAL OPSTUVNINGSPAKNING	ANTAL (pr. kolli)	TYPE	BEMÆRK	(varenummer)
<b>JUAL</b> <b>Opstuvningspakning</b> 	5 stk.	Til Ø 40 mm tagbrønd	Passer til rør med indv. diameter Ø 46-49 mm	(1504001)
		Til Ø 40 mm tagbrønd	Passer til rør med indv. diameter Ø 59-62 mm	(1504002)
		Til Ø 50 mm tagbrønd	Passer til rør med indv. diameter Ø 59-62 mm	(1504003)
		Til Ø 50 mm tagbrønd	Passer til rør med indv. diameter Ø 71-74 mm	(1504004)
		Til Ø 63 mm tagbrønd	Passer til rør med indv. diameter Ø 71-74 mm	(1504005)
		Til Ø 63 mm tagbrønd	Passer til rør med indv. diameter Ø 85-89 mm	(1504006)
		Til Ø 75 mm tagbrønd	Passer til rør med indv. diameter Ø 85-89 mm	(1504007)
		Til Ø 75 mm tagbrønd	Passer til rør med indv. diameter Ø 105-109 mm	(1504008)
		Til Ø 90 mm tagbrønd	Passer til rør med indv. diameter Ø 105-109 mm	(1504009)
		Til Ø 90 mm tagbrønd	Passer til rør med indv. diameter Ø 119-124 mm	(1504010)
		Til Ø 110 mm tagbrønd	Passer til rør med indv. diameter Ø 119-124 mm	(1504011)
		Til Ø 110 mm tagbrønd	Passer til rør med indv. diameter Ø 139-144 mm	(1504012)
		Til Ø 125 mm tagbrønd	Passer til rør med indv. diameter Ø 139-144 mm	(1504013)
		Til Ø 125 mm tagbrønd	Passer til rør med indv. diameter Ø 154-159 mm	(1504014)
		Til Ø 145 mm tagbrønd	Passer til rør med indv. diameter Ø 152-159 mm	(1504015)
		Til Ø 160 mm tagbrønd	Passer til rør med indv. diameter Ø 189-194 mm	(1504016)
		Til Ø 160 mm tagbrønd	Passer til rør med indv. diameter Ø 194-198 mm	(1504017)

**TÜVRheinland®**  
 Precisely Right.  
 TÜV Rheinland-testet.  
 Godkendt i henhold til DS/EN-1253.

## KOMPLET SERIE AF OPSTUVNINGSPAKNINGER

Opstuvningspakningerne er tilpasset JUAL Tagbrønde og standardiserede rørdiameter

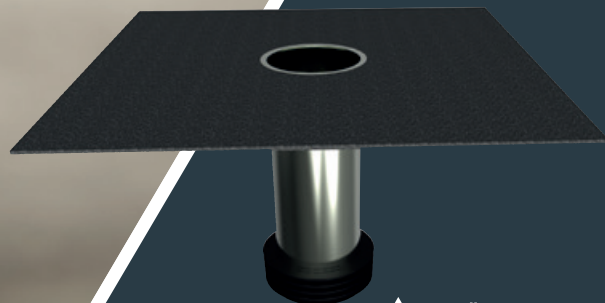













**TÜVRheinland®**  
 Precisely Right.

Opstuvningspakninger kan leveres til alle JUAL Tagbrønde.





Produktserien er godkendt efter EN1253 af TÜV Rheinland.







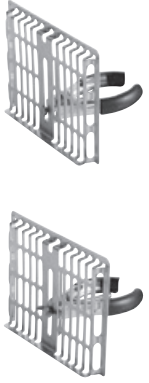
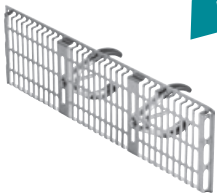
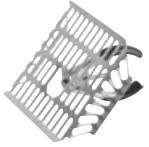





JUAL BLADFANG	ANTAL (pr. kolli)	MATERIALE	ANVENDELSE	(varenummer)
Universal Bladfang 	10 stk.	0,8 mm Rustfrit stål	Kan fastspændes i tagbrønde fra Ø 50 mm til Ø 160 mm	(72000)
Universal Bladfang XL 	Efter ordre	1,0 mm Rustfrit stål	Kan fastspændes i tagbrønde fra Ø 110 mm til Ø 250 mm	(72000XL)
Monsoon Bladfang  	10 stk.	0,8 mm Rustfrit stål	Kan fastspændes i tagbrønde fra Ø 50 mm til Ø 160 mm	(75000)
Monsoon Bladfang til nødafvanding (høj model)  	10 stk.	0,8 mm Rustfrit stål	Kan fastspændes i tagbrønde fra Ø 110 mm til Ø 160 mm	(75000S)
Bladfang Lyn 	10 stk.	Ø 3,0 mm Rustfrit stål	Passer til tagbrønde fra Ø 50 mm til Ø 110 mm	(70001)
Bladfang Lyn XL 	10 stk.	Ø 5,0 mm Rustfrit stål	Passer til tagbrønde fra Ø 125 mm til Ø 160 mm	(70001XL)
Trådkugle 	10 stk.	Ø 3,0 mm Plastbelagt stål	Passer til tagbrønde fra Ø 50 mm til Ø 110 mm	(70000)
Trådkugle XL 	10 stk.	Ø 3,0 mm Plastbelagt stål	Passer til tagbrønde fra Ø 125 mm til Ø 160 mm	(70002)
Cylinder Bladfang 	Efter ordre	0,5 mm Rustfrit stål	Passer til JUAL Tagbrønd Ø 50 mm Passer til JUAL Tagbrønd Ø 63 mm Passer til JUAL Tagbrønd Ø 75 mm Passer til JUAL Tagbrønd Ø 90 mm Passer til JUAL Tagbrønd Ø 110 mm Passer til JUAL Tagbrønd Ø 125 mm Passer til JUAL Tagbrønd Ø 145 mm Passer til JUAL Tagbrønd Ø 160 mm	(74050-50) (74050-63) (74050-75) (74050-90) (74050-110) (74050-125) (74050-145) (74050-160)

Bladfang pakkes sammen med brønde efter ordre.

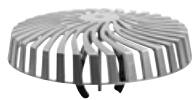

JUAL BLADFANG	ANTAL (pr. kolli)	MATERIALE	ANVENDELSE	(varenummer)
Turbine Bladfang 	1 stk.	4,0 mm Trykstøbt aluminium	Kan fastspændes i tagbrønde fra Ø 50 mm til Ø 160 mm	(74000)
Balkonrist 	Efter ordre	1,0 mm Rustfrit stål	Kan fastspændes i tagbrønde fra Ø 50 mm til Ø 110 mm	(74001)
Horisontal Bladfang 	Efter ordre	0,8 mm Rustfrit stål	<b>Universal Bladfang til alle JUAL Horisontal Tagbrønde</b> Passer til Ø 50 mm  Passer til Ø 75, Ø 90 og Ø 110 mm	(720001H)  (72000H)
Horisontal Bladfang - flad 	Efter ordre	0,8 mm Rustfrit stål	<b>Universal Bladfang med sekskantbolt til alle JUAL Horisontal Tagbrønde</b>  Passer til Ø 50 mm  Passer til Ø 75, Ø 90 og Ø 110 mm  <b>Universal Bladfang med vingskrue til alle JUAL Horisontal Tagbrønde</b>  Passer til Ø 50 mm  Passer til Ø 75, Ø 90 og Ø 110 mm	(72001HF)  (72000HF)  (72001HFV)  (72000HFV)
Bladfang til Rektangulær Tagbrønd 	Efter ordre	1,0 mm Rustfrit stål	<b>Rektangulær Tagbrønd:</b> Bredde 77-150 mm  Bredde 180-275 mm  Bredde 230-375 mm  Bredde 350-475 mm  Bredde 410-500 mm	(72000HR-150)  (72000HR-200)  (72000HR-300)  (72000HR-400)  (72000HR-500)
Bladfang til Trekantliste 	Efter ordre	1,0 mm Rustfrit stål	Rektangulær Tagbrød til Trekantliste; 77x56 og 95x56 mm	(72000HK)
Terrasserist 	Efter ordre	1,0 mm Rustfrit stål	Rist til afvanding ved fliser eller anden belægning Højde 60 - 90 mm  Højde 90 -120 mm  Højde 120 -150 mm	(74506)  (74509)  (74512)

## AFVANDINGSKAPACITET

		Ø 50 mm	Ø 63 mm	Ø 75 mm	Ø 90 mm	Ø 110 mm	Ø 125 mm
Universal Bladfang		L / sek. 3,0	L / sek. 2,0	L / sek. 2,8	L / sek. 3,6	L / sek. 4,2	L / sek. 8,5
Monsoon Bladfang		L / sek. 5,3	L / sek. 8,8	L / sek. 9,6	L / sek. 12,0	L / sek. 12,1	L / sek. 19,1
Monsoon Bladfang nødafvanding		L / sek. X	L / sek. X	L / sek. X	L / sek. X	L / sek. 7,5 / 15,0	L / sek. X
"Lyn" Bladfang		L / sek. 3,4	L / sek. 3,5	L / sek. 3,8	L / sek. 4,4	L / sek. 5,7	L / sek. 8,4
Trådkugle Bladfang		L / sek. 3,4	L / sek. 3,5	L / sek. 3,8	L / sek. 4,4	L / sek. 5,7	L / sek. 8,4
Cylinder Bladfang		L / sek. 0,9	L / sek. 1,0	L / sek. 1,4	L / sek. 1,7	L / sek. 2,7	L / sek. 4,4
Turbine Bladfang		L / sek. 2,3	L / sek. 2,5	L / sek. 3,8	L / sek. 4,3	L / sek. 4,5	L / sek. 6,7
Balkon Bladfang		L / sek. 3,3	L / sek. 3,5	L / sek. 3,8	L / sek. 3,9	L / sek. 2,7	L / sek. X
Horisontal Bladfang		L / sek. 0,5	L / sek. X	L / sek. 0,7	L / sek. X	L / sek. 1,1	L / sek. X

Målinger efter EN-1253-2, ved 35 mm vandhøjde.

# AFVANDINGSTILBEHØR

JUAL FORLÆNGERRØR	ANTAL (pr. kolli)	TYPE	300 MM RØR (varenummer)	600 MM RØR (varenummer)
Rustfrit stålør  	Efter ordre	JUAL Forlængerrør (Ø 50 mm)	(457050-300)	(457050-600)
		JUAL Forlængerrør (Ø 63 mm)	(457063-300)	(457063-600)
		JUAL Forlængerrør (Ø 75 mm)	(457075-300)	(457075-600)
		JUAL Forlængerrør (Ø 90 mm)	(457090-300)	(457090-600)
		JUAL Forlængerrør (Ø 110 mm)	(457110-300)	(457110-600)
		JUAL Forlængerrør (Ø 125 mm)	(457125-300)	(457125-600)
		JUAL Forlængerrør (Ø 145 mm)	(457145-300)	(457145-600)
		JUAL Forlængerrør (Ø 160 mm)	(457160-300)	(457160-600)

JUAL TILBEHØR	ANTAL (pr. kolli)	DIMENSION	MATERIALE	(varenummer)
Reduktionsrør med muffe 	Efter ordre	Ø 50/Ø 63 mm, L=165 mm	Rustfrit stål	(460050063)
		Ø 63/Ø 75 mm, L=165 mm		(460063075)
		Ø 75/Ø 90 mm, L=165 mm		(460075090)
		Ø 90/Ø 110 mm, L=165 mm		(460090110)
		Ø 110/Ø 125 mm, L=175 mm		(460110125)
		Ø 125/Ø 145 mm, L=175 mm		(460125145)
		Ø 145/Ø 160 mm, L=175 mm		(460145160)
90° Vinkelrør 	Efter ordre	Ø 50 mm, H=158 mm, L=193 mm	Rustfrit stål	(4582050-90)
		Ø 63 mm, H=170 mm, L=193 mm		(4582063-90)
		Ø 75 mm, H=182 mm, L=193 mm		(4582075-90)
		Ø 90 mm, H=197 mm, L=193 mm		(4582090-90)
		Ø 110 mm, H=217 mm, L=193 mm		(4582110-90)
		Ø 125 mm, H=233 mm, L=293 mm		(4582125-90)
		Ø 145 mm, H=252 mm, L=293 mm		(4582145-90)
Ø 160 mm, H=267 mm, L=293 mm	(4582160-90)			



JUAL TILBEHØR	ANTAL (pr. kolli)	BEMÆRKNINGER	TYPE	(varenummer)
Varmekabel til tagbrønd 	Efter ordre	Varmekablet leveres komplet monteret på JUAL Tagbrønd	Selvregulerende varmekabel 230V	(77777-300)
			Ø50-Ø90 mm / 4,5W	(77777-600)
Varmekabel-kit 		Varmekabel-kit til JUAL Tagbrønd	Selvregulerende varmekabel 230V	(77778-300)
			Ø50-Ø90 mm / 4,5W	(77778-600)
			Ø110-Ø160 mm / 9,0W	

JUAL O-RINGE	ANTAL (pr. kolli)	BEMÆRKNINGER	INDHOLD	(varenummer)
O-Ringe 	1 ps. (3x10 stk.)	Komplet sortiment til Ø 50 mm tagbrønd	10 stk. Ø 6 mm 10 stk. Ø 10 mm 10 stk. Ø 12 mm	(69950)
		Komplet sortiment til Ø 63 mm tagbrønd	10 stk. Ø 8 mm 10 stk. Ø 10 mm 10 stk. Ø 12 mm	(69963)
		Komplet sortiment til Ø 75 mm tagbrønd	10 stk. Ø 6 mm 10 stk. Ø 10 mm 10 stk. Ø 12 mm	(69975)
		Komplet sortiment til Ø 90 mm tagbrønd	10 stk. Ø 6 mm 10 stk. Ø 8 mm 10 stk. Ø 12 mm	(69990)



FÅ EN FLOT  
AFSLUTNING VED  
GENNEBRYDNING  
AF MURKRONEN

VI HAR AFDÆKNINGS-  
PLADER SOM PASSER  
TIL ALLE TAGBRØNDE

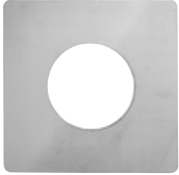
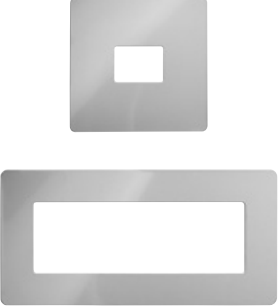
JUAL AFDÆKNINGSPLADE	ANTAL (pr. kolli)	MATERIALE	ANVENDELSE	DIMENSION (hul/plade)	PASSER TIL RØRDIM.	(varenummer)
<p>Afdækningsplade - rund</p>  <p><b>NYHED</b></p>		Rustfrit stål	Til afdækning af hul ved gennemføring af tagbrønd gennem facaden	Ø 52/Ø 150 mm	Ø 50 mm	(46 201 050 150)
				Ø 65/Ø 150 mm	Ø 63 mm	(46 201 063 150)
				Ø 77/Ø 150 mm	Ø 75 mm	(46 201 075 150)
				Ø 93/Ø 175 mm	Ø 90 mm	(46 201 090 175)
				Ø 112/Ø 175 mm	Ø 110 mm	(46 201 110 175)
				Ø 127/Ø 200 mm	Ø 125 mm	(46 201 125 200)
				Ø 147/Ø 225 mm	Ø 145 mm	(46 201 145 225)
				Ø 162/Ø 225 mm	Ø 160 mm	(46 201 160 225)
<p>Afdækningsplade - kvadratisk med rundt hul</p>  <p><b>NYHED</b></p>	Efter ordre	Rustfrit stål	Til afdækning af hul ved gennemføring af tagbrønd gennem facaden	Ø 52/ 150x150 mm	Ø 50 mm	(46 203 050 150)
				Ø 65/ 163x163 mm	Ø 63 mm	(46 203 063 163)
				Ø 77/ 175x175 mm	Ø 75 mm	(46 203 075 175)
				Ø 92/ 190x190 mm	Ø 90 mm	(46 203 090 190)
				Ø 112/ 210x210 mm	Ø 110 mm	(46 203 110 210)
				Ø 127/ 225x225 mm	Ø 125 mm	(46 203 125 225)
				Ø 147/ 245x245 mm	Ø 145 mm	(46 203 145 245)
				Ø 162/ 260x260 mm	Ø 160 mm	(46 203 160 260)
<p>Afdækningsplade - med rektangulært hul</p>  <p><b>NYHED</b></p>		Rustfrit stål	Fastgøres med montagelim	81x60 / 230x230 mm	77x56 mm	(46 204 077 056)
				99x70 / 230x230 mm	95x56 mm	(46 204 095 056)
				120x70 / 230x230 mm	124x74 mm	(46 204 120 070)
				140x60 / 230x230 mm	144x64 mm	(46 204 140 060)
				154x54 / 300x230 mm	150x50 mm	(46 204 150 050)
				154x104 / 300x230 mm	150x100 mm	(46 204 150 100)
				204x54 / 350x200 mm	200x50 mm	(46 204 200 050)
				204x104 / 350x200 mm	200x100 mm	(46 204 200 100)
				219x74 / 350x200 mm	215x70 mm	(46 204 215 070)
				244x54 / 350x200 mm	240x50 mm	(46 204 240 050)
				304x104 / 400x200 mm	300x100 mm	(46 204 300 100)
				404x104 / 500x200 mm	400x100 mm	(46 204 400 100)
				504x104 / 600x200 mm	500x100 mm	(46 204 500 100)

JUAL AFDÆKNINGSPLADE	ANTAL (pr. kolli)	MATERIALE	ANVENDELSE	DIMENSION (hul/plade)	PASSER TIL	(varenummer)
NYHED  Afdækningsplade - med ovalt hul  	Efter ordre	Rustfrit stål	Til afdækning af hul ved gennemføring af tagbrønd gennem facaden	142x64 / 300x300 mm	Murkrone skålbønd	(46 205 142 064)
			Fastgøres med montagelim	155x77 / 300x300 mm	Vinkel- overgang til murkrone skålbønd	(46 205 155 077)



JUAL TILBEHØR	ANTAL (pr. kolli)	ANVENDELSE/DIMENSION	MATERIALE	(varenummer)
Tagpapstykke - underpap   NYHED	Efter ordre	Placering under tagbrønde op til Ø 125 mm	SBS	(70 600 600 130-SBS)
		600x600 mm, Ø 130 mm hul	APP	(70 600 600 130-APP)
		Placering under tagbrønde Ø 145 - Ø 160 mm	SBS	(70 600 600 165-SBS)
		600x600 mm, Ø 165 mm hul	APP	(70 600 600 165-APP)







HUSK PAPSTYKKE  
UNDER TAGBRØNDEN!

Underpap-stykker  
på 600 x 600 mm  
kan købes med til  
tagbrønde, faldstamme-  
inddækninger m.m.

# UDLUFTNING

JUAL AFTRÆKSHÆTTE HÆLDNINGSTAG	ANTAL (pr. kolli)	ANVENDELSE	MATERIALE	(varenummer)
Rund aftrækshætte universal smig 10-48° med Perform inddæknings- materiale 	1 stk.	Justerbar udluftningshætte, 10°-48°	Ø 125 mm med sort Perform	(820125-1048-501)
			Ø 160 mm med sort Perform	(820160-1048-501)
Rund aftrækshætte universal smig 10-48° med perforeret flange 	1 stk.	Justerbar udluftningshætte, 10°-48°	Ø 125 mm til tagpap	(820125-1048-171)
			Ø 160 mm til tagpap	(820160-1048-171)

JUAL AFTRÆKSHÆTTE FLADT TAG	ANTAL (pr. kolli)	ANVENDELSE	MATERIALE	(varenummer)
Aftrækshætte Sortlakeret aluminium med aftagelig top 200 x 200 mm 	1 stk.	Aftrækshætte til fladt tagpaptag	200 x 200 mm Sortlakeret alu.	(81020)
			200 x 200 mm Sortlakeret alu., isoleret	(81020iso)
Aftrækshætte Rustfrit stål 0,5 mm med aftagelig top 200 x 200 mm 	1 stk.	Aftrækshætte til fladt tagpaptag	200 x 200 mm Rustfrit stål (0,5 mm)	(78000)
			200 x 200 mm Rustfrit stål (0,5 mm) isoleret	(78000iso)
Aftrækshætte Zink 14 med aftagelig top 200 x 200 mm 	1 stk.	Aftrækshætte til fladt tagpaptag	200 x 200 mm Zink 14 (0,8 mm)	(79020-14)
			200 x 200 mm Zink 14 (0,8 mm) isoleret	(79020-14iso)
PLASTIGEN Aftrækshætte til tagpap med aftagelig top 200 x 200 mm 	10 stk.	Aftrækshætte til fladt tagpaptag	200 x 200 mm Sort ASA	(50010)
			200 x 200 mm Sort ASA, isoleret	(50010iso)
PLASTIGEN Aftrækshætte til PVC-folie med aftagelig top 200 x 200 mm 	10 stk.	Aftrækshætte til fladt folietag	200 x 200 mm Mørk grå PVC	(60009)
			200 x 200 mm Mørk grå PVC, isoleret	(60009iso)



JUAL AFTRÆKSHÆTTE HÆLDNINGSTAG	ANTAL (pr. kolli)	ANVENDELSE	MATERIALE	(varenummer)
Aftrækshætte universal smig Sortlakeret aluminium 11-55° med aftagelig top 200 x 200 mm	1 stk.	Aftrækshætte med trinløst indstilleligt smig samt aftagelig top	200 x 200 mm Sortlakeret aluminium 200 x 200 mm Sortlakeret aluminium isoleret	(81020US) (81020US-iso)
Aftrækshætte universal smig Zink 14 11-55° med aftagelig top 200 x 200 mm	1 stk.	Aftrækshætte med trinløst indstilleligt smig samt aftagelig top	200 x 200 mm Zink 14 200 x 200 mm Zink 14, isoleret	(79020US) (79020US-iso)
PLASTIGEN Aftrækshætte universal smig til tagpap 11-55° med aftagelig top 200 x 200 mm	10 stk.	Aftrækshætte med trinløst indstilleligt smig samt aftagelig top	200 x 200 mm Sort ASA 200 x 200 mm Sort ASA, isoleret	(50015) (50015iso)
PLASTIGEN Aftrækshætte universal smig til PVC-FOLIE 11-55° med aftagelig top 200 x 200 mm	10 stk.	Aftrækshætte med trinløst indstilleligt smig samt aftagelig top	200 x 200 mm Mørk grå PVC 200 x 200 mm Mørk grå PVC, isoleret	(60015) (60015iso)

JUAL AFTRÆKSHÆTTE TILBEHØR	ANTAL (pr. kolli)	ANVENDELSE	MATERIALE	(varenummer)
JUAL Aftrækshætte sortlakeret aluminium standard	1 stk.	Løs top til JUAL Aftrækshætte 200 x 200 mm	Sortlakeret aluminium 50 mm kant	(81700)
JUAL Aftrækshætte sortlakeret aluminium ekstra slagregnessikker		Løs top til JUAL Aftrækshætte 200 x 200 mm	Sortlakeret aluminium 100 mm kant	(81800)
PLASTIGEN Aftrækshætte med løs top til 200 x 200 mm		Løs top til PLASTIGEN Aftrækshætte 200 x 200 mm	ASA, sort PVC, mørk grå	(50700) (60700)
Beskyttelses- kappe		Beskyttelseskappe til aftrækshætte 200 x 200 mm	2,0 mm aluminium	(50030)



JUAL LEVERER OGSÅ  
**SPECIALPRODUKTER**  
TILPASSET DINE  
ØNSKER TIL DIMENSION,  
MATERIALE OG FARVE

KONTAKT OS PÅ  
76 83 11 33 // JUAL@JUAL.DK

JUAL UDLUFTNINGSTOP	OVERFLADE	ANTAL (pr. kolli)	ANVENDELSE	PASSER TIL JUAL VARENUMMER	(varenummer)
Udluftningstop Rustfrit stål 	Blank	Efter ordre	Til Ø 50 mm rør	78040-xxx, 78050-xxx	(777050)
	Blank		Til Ø 63 mm rør	78063-xxx	(777063)
	Blank		Til Ø 75 mm rør	78075-63-xxx, 78075-xxx	(777075)
	Blank		Til Ø 90 mm rør	78090-xxx	(777090)
	Mat		Til Ø 93 mm rør	76075-xxx, 76050-xxx	(777093)
	Blank		Til Ø 110 mm rør	78110-90-xxx, 78110-xxx	(777110)
	Blank		Til Ø 125 mm rør	78125-110-xxx, 78125-xxx	(777125)
	Mat		Til Ø 130 mm rør	76110-xxx	(777130)
	Blank		Til Ø 145 mm rør	78160-145-xxx	(777145)
	Blank		Til Ø 160 mm rør	78160-xxx	(777160)
	Blank		Til Ø 200 mm rør	78200-180-xxx, 78200-xxx	(777200)
Udluftningstop Slagregnsikker Rustfrit stål 	Blank	Efter ordre	Til Ø 50 mm rør	78040-xxx, 78050-xxx	(778050)
	Blank		Til Ø 63 mm rør	78063-xxx	(778063)
	Blank		Til Ø 75 mm rør	78075-63-xxx, 78075-xxx	(778075)
	Blank		Til Ø 90 mm rør	78090-xxx	(778090)
	Mat		Til Ø 93 mm rør	76075-xxx, 76050-xxx	(778093)
	Blank		Til Ø 110 mm rør	78110-90-xxx, 78110-xxx	(778110)
	Blank		Til Ø 125 mm rør	78125-110-xxx, 78125-xxx	(778125)
	Mat		Til Ø 130 mm rør	76110-xxx	(778130)
	Blank		Til Ø 145 mm rør	78160-145-xxx	(778145)
	Blank		Til Ø 160 mm rør	78160-xxx	(778160)
	Mat		Til Ø 185 mm rør	76160-xxx	(778185)
Blank	Til Ø 200 mm rør	78200-180-xxx, 78200-xxx	(778200)		







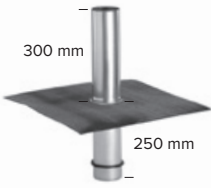
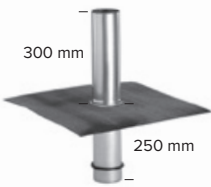
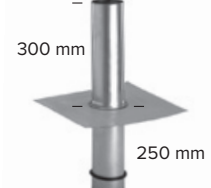
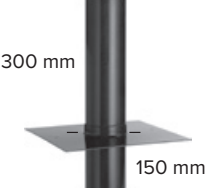



VORES STANDARD-  
SORTIMENT ER BREDT  
OG DYBT, **OG VI KAN  
LEVERE LANGT DE  
FLESTE PRODUKTER  
FRA DAG TIL DAG**





JUAL FALDSTAMMEINDDÆKNING (MED DOBBELTRØR)	ANTAL (pr. kolli)	RØR diameter (udvendig / indvendig)	ANVENDELSE (passer til)	(varenummer)
Faldstammeinddækning med dobbeltrør i rustfrit stål. Tagpap  <b>MATERIALEVALG:</b> SBS: (-101) APP: (-114)	5 stk.	Ø 95 mm / Ø 40 mm	Passer til Ø 50 mm rør	(76050-1xx)
		Ø 90 mm / Ø 60 mm	Passer til Ø 75 mm rør	(76075-1xx)
		Ø 110 mm / Ø 75 mm	Passer til Ø 90 mm rør	(76090-1xx)
		Ø 125 mm / Ø 90 mm	Passer til Ø 110 mm rør	(76110-1xx)
Faldstammeinddækning med dobbeltrør i rustfrit stål. Derbigum tagpap		Ø 95 mm / Ø 40 mm	Passer til Ø 50 mm rør	(76050-103)
		Ø 90 mm / Ø 60 mm	Passer til Ø 75 mm rør	(76075-103)
		Ø 110 mm / Ø 75 mm	Passer til Ø 90 mm rør	(76090-103)
	Ø 125 mm / Ø 90 mm	Passer til Ø 110 mm rør	(76110-103)	
Faldstammeinddækning med dobbeltrør i rustfrit stål. Tagfolie  <b>MATERIALEVALG:</b> Se skema side 19 for folier	Ø 95 mm / Ø 40 mm	Passer til Ø 50 mm rør	(76050-2xx)	
	Ø 90 mm / Ø 60 mm	Passer til Ø 75 mm rør	(76075-2xx)	
	Ø 110 mm / Ø 75 mm	Passer til Ø 90 mm rør	(76090-2xx)	
	Ø 125 mm / Ø 90 mm	Passer til Ø 110 mm rør	(76110-2xx)	
Faldstammeinddækning med dobbeltrør i rustfrit stål	Ø 95 mm / Ø 40 mm	Passer til Ø 50 mm rør	(76050-190)	
	Ø 90 mm / Ø 60 mm	Passer til Ø 75 mm rør	(76075-190)	
	Ø 110 mm / Ø 75 mm	Passer til Ø 90 mm rør	(76090-190)	
	Ø 125 mm / Ø 90 mm	Passer til Ø 110 mm rør	(76110-190)	
Faldstammeinddækning med dobbeltrør i Zink 14	Ø 95 mm / Ø 40 mm	Passer til Ø 50 mm rør	(77050-14)	
	Ø 90 mm / Ø 60 mm	Passer til Ø 75 mm rør	(77075-14)	
	Ø 110 mm / Ø 75 mm	Passer til Ø 90 mm rør	(77090-14)	
	Ø 125 mm / Ø 90 mm	Passer til Ø 110 mm rør	(77110-14)	
<b>PLASTIGEN</b> Faldstammeinddækning med dobbeltrør i PVC	Ø 95 mm / Ø 40 mm	Passer til Ø 50 mm rør	(51050)	
	Ø 90 mm / Ø 63 mm	Passer til Ø 75 mm rør	(51075)	
	Ø 110 mm / Ø 75 mm	Passer til Ø 90 mm rør	(51090)	
	Ø 125 mm / Ø 90 mm	Passer til Ø 110 mm rør	(51110)	

JUAL FALDSTAMMEINDDÆKNING (INDSTIKSMODEL)	ANTAL (pr. kolti)	RØR diameter (udvendig)	ANVENDELSE	(varenummer)
<b>Faldstammeinddækning indstiksmodel. Rustfrit stålør tagpap</b>  <b>MATERIALEVALG:</b> SBS: (-101) APP: (-114)	5 stk.	Ø 40 mm	Passer til Ø 50 mm rør	(78040-1xx)
		Ø 63 mm	Passer til Ø 75 mm rør	(78063-1xx)
		Ø 75 mm	Passer til Ø 90 mm rør	(78075-1xx)
		Ø 90 mm	Passer til Ø110 mm rør	(78090-1xx)
<b>Faldstammeinddækning indstiksmodel. Rustfrit stålør. Derbigum tagpap</b> 		Ø 40 mm	Passer til Ø 50 mm rør	(78040-103)
		Ø 63 mm	Passer til Ø 75 mm rør	(78063-103)
		Ø 75 mm	Passer til Ø 90 mm rør	(78075-103)
		Ø 90 mm	Passer til Ø110 mm rør	(78090-103)
<b>Faldstammeinddækning indstiksmodel. Rustfrit stålør. Tagfolie</b>  <b>MATERIALEVALG:</b> Se skema på side 19 for folier		Ø 40 mm	Passer til Ø 50 mm rør	(78040-2xx)
		Ø 63 mm	Passer til Ø 75 mm rør	(78063-2xx)
		Ø 75 mm	Passer til Ø 90 mm rør	(78075-2xx)
		Ø 90 mm	Passer til Ø110 mm rør	(78090-2xx)
<b>PLASTIGEN Faldstammeinddækning indstiksmodel</b> 		Ø 40 mm	Passer til Ø 50 mm rør	(50040)
		Ø 63 mm	Passer til Ø 75 mm rør	(50063)
		Ø 80 mm	Passer til Ø 90 mm rør	(50080)
		Ø 90 mm	Passer til Ø110 mm rør	(50090)

**TÜVRheinland®**  
 Precisely Right.  
 TÜV Rheinland-tested.  
 Certified according to EN 1253

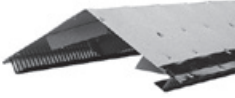



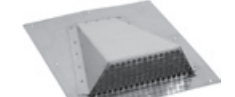



JUAL FALDSTAMMEINDSATS TIL 200X200 MM HÆTTE I ZINK, ALU ELLER RUSTFRIT STÅL	ANTAL (pr. kolti)	ANVENDELSE	(varenummer)
<b>Rør Ø 40 mm</b> 	1 stk.	Passer til Ø 50 mm rør og JUAL Aftrækshætte 200x200 mm	(800050)
<b>Rør Ø 63 mm</b> 		Passer til Ø 75 mm rør og JUAL Aftrækshætte 200x200 mm	(800075)
<b>Rør Ø 75 mm</b> 		Passer til Ø 90 mm rør og JUAL Aftrækshætte 200x200 mm	(800090)
<b>Rør Ø 90 mm</b> 		Passer til Ø 110 mm rør og JUAL Aftrækshætte 200x200 mm	(800110)

PLASTIGEN FALDSTAMMEINDSATS TIL 200X200 MM HÆTTE I ASA OG PVC	ANTAL (pr. kolli)	ANVENDELSE	(varenummer)
Rør Ø 40 mm 	1 stk.	Passer til Ø 50 mm rør og PLASTIGEN Aftrækshætte 200x200 mm	(810050)
Rør Ø 63 mm 		Passer til Ø 75 mm rør og PLASTIGEN Aftrækshætte 200x200 mm	(810075)
Rør Ø 80 mm 		Passer til Ø 90 mm rør og PLASTIGEN Aftrækshætte 200x200 mm	(810090)
Rør Ø 90 mm 		Passer til Ø 110 mm rør og PLASTIGEN Aftrækshætte 200x200 mm	(810110)



JUAL RYGNINGSUDLUFTNING / SHEDLOCK	ANTAL (pr. kolli)	ANVENDELSE	MATERIALE	(varenummer)
JUAL Rygnings- udluftning aluzink med sort front 	10 stk.	Rygningsudluftning til tagpaptage med hældning. Sværtet 50 mm i kanten.	0,6 mm aluzink med rustfrit net Længde 1 meter	(84000)
JUAL Rygnings- udluftning i syrefast rustfrit stål  <b>NYHED</b>	10 stk.	Rygningsudluftning til tagpaptage med hældning.	0,5 mm syrefast rustfrit stål med rustfrit net Længde 1 meter	(84001)
JUAL Endebund til Rygningsudluftning 	1 stk.	Endebund til rygningsudluftning	0,63 mm galvaniseret stål  0,5 mm syrefast rustfrit stål	(84100) (84101)
JUAL Overgangs- udluftning med sort front 	10 stk.	Udluftning til overgang mellem væg og skråt tag	0,6 mm aluzink med rustfrit net Længde 1 meter	(84050)
JUAL Shedlock Ø 75 mm med sort front 	50 stk.	Udluftnings-/ trykudligningshætte til hældningstage	Ø 75 mm rustfrit stål	(74075-22)
JUAL Shedlock Ø 110 mm med sort front 	50 stk.	Udluftnings-/ trykudligningshætte til hældningstage	Ø 110 mm rustfrit stål	(74110-22)

JUAL UNDERTAGSUDLUFTNING	ANTAL (pr. kolli)	TYPE	(varenummer)
PLASTIGEN Konstruktions- udluftning 	40 stk.	Sort ABS til tagpap: Konstruktionsudluftning Ø 75 mm ABS	(60450)
		Koksgrå PVC til tagfolie: Konstruktionsudluftning Ø 75 mm PVC	(60460)
		Løst insektnet 100 x 100 mm rustfrit stål	(60461)



JUAL AIRLIFT		ANTAL (pr. kolli)	ANVENDELSE	TYPE	(varenummer)
Airlift Ø 32 mm		10 stk.	Hærværkssikker hætte rustfrit stål med plasttop boltet fast	Ø 32 mm + (sugende) Rustfrit stål	(72400)
				Ø 32 mm 0 (ikke sugende) Rustfrit stål	(72450)
Airlift Ø 32 mm		10 stk.	Ekstra hærværkssikker hætte lavet i kraftigt 2 mm sort lak. rustfrit stål	Ø 32 mm + (sugende) Rustfrit stål	(72425)
				Ø 32 mm 0 (ikke sugende) Rustfrit stål	(72435)
PLASTIGEN Airlift + Ø 32 mm		40 stk.	Sugende hætte	Sort glasfiberarmeret nylon til tagpap Ø 32 mm + glasfiberarmeret	(61001)
				Koksgrå PVC til folie Ø 32 mm + PVC	(60001)
PLASTIGEN Airlift 0 Ø 32 mm		40 stk.	Ikke sugende hætte	Sort glasfiberarmeret nylon til tagpap Ø 32 mm 0 glasfiberarmeret	(61002)
				Koksgrå PVC til folie Ø 32 mm 0 PVC	(60002)
PLASTIGEN Airlift + Ø 75 mm		30 stk.	Sugende hætte	Sort ABS til tagpap Ø 75 mm + ABS	(50003)
				Koksgrå PVC til folie Ø 75 mm + PVC	(60003)
PLASTIGEN Airlift 0 Ø 75 mm		30 stk.	Ikke sugende hætte	Sort ABS til tagpap Ø 75 mm 0 ABS	(50004)
				Koksgrå PVC til folie Ø 75 mm 0 PVC	(60004)
Top til Ø 32 mm Airlift		Efter ordre	-	Ø 32 mm rør – sort	(60000S)
				Ø 32 mm rør – grå	(60000G)
Top til Ø 75 mm Airlift		Efter ordre	-	Ø 75 mm rør – sort	(61000S)
				Ø 75 mm rør – grå	(61000G)
Top til Breeze hætter		Efter ordre	-	Ø 25 mm rør – sort	(63001)
				Ø 63 mm rør – sort	(63002)
				Ø 75 mm rør – sort	(63003)
				Ø 110 mm rør – sort	(63004)
				Ø 160 mm rør – sort	(63005)

# TAGINDDÆKNING

JUAL TAGINDDÆKNING TIL BALANCERET AFTRÆK	ANTAL (pr. kolti)	ANVENDELSE	MATERIALE	(varenummer)
Taginddækning til balanceret aftræk universal smig 10-48° med Perform inddæknings- materiale  <span style="color: green; font-weight: bold;">NYHED</span>	1 stk.	inddækning af balanceret aftræk på hældningstag med profileret tagflade	Ø 125 mm aluminium med sort Perform inddækningsmateriale	(310125-1048-501)
Ø 160 mm aluminium med sort Perform inddækningsmateriale			(310160-1048-501)	
Taginddækning til balanceret aftræk universal smig 10-48° med perforeret flange  <span style="color: green; font-weight: bold;">NYHED</span>		inddækning af balanceret aftræk på hældningstag med tagpap	Ø 125 mm aluminium	(310125-1048-171)
			Ø 160 mm aluminium	(310160-1048-171)

TAGINDDÆKNING



**JUSTERBAR  
TAGINDDÆKNING  
I ALUMINIUM**  
til balanceret aftræk

- Justerbar fra 10° til 48°
- Ø 125 og Ø 160 mm

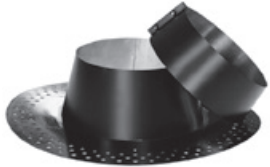

JUAL TAGINDDÆKNING TIL FLADT TAG M/ TAGPAP 0-10°	ANTAL (pr. kolli)	DIAMETER (Ø mm)	MEMBRAN	BLANK (varenummer)	SORT (varenummer)
<p>Taginddækning til fladt tag i rustfrit stål 0-10°</p>  <p>Med blank spændekrave</p>  <p>Med fulddækkende sortlakeret spændekrave</p> <p><b>MATERIALEVALG:</b> SBS-membran (-107)</p> <p>Kontakt os, hvis du ønsker en Derbigum (-103) eller APP-membran (-114)</p>	Efter ordre	Ø 80 mm	500x500	(300080-0010-107)	(310080-0010-107)
		Ø 100 mm	500x500	(300100-0010-107)	(310100-0010-107)
		Ø 110 mm	500x500	(300110-0010-107)	(310110-0010-107)
		Ø 125 mm	600x600	(300125-0010-107)	(310125-0010-107)
		Ø 140 mm	600x600	(300140-0010-107)	(310140-0010-107)
		Ø 150 mm	600x600	(300150-0010-107)	(310150-0010-107)
		Ø 160 mm	600x600	(300160-0010-107)	(310160-0010-107)
		Ø 180 mm	600x600	(300180-0010-107)	(310180-0010-107)
		Ø 187 mm	600x600	(300187-0010-107)	(310187-0010-107)
		Ø 200 mm	600x600	(300200-0010-107)	(310200-0010-107)
		Ø 217 mm	600x600	(300217-0010-107)	(310217-0010-107)
		Ø 224 mm	630x630	(300224-0010-107)	(310224-0010-107)
		Ø 230 mm	630x630	(300230-0010-107)	(310230-0010-107)
		Ø 250 mm	630x630	(300250-0010-107)	(310250-0010-107)
		Ø 270 mm	700x700	(300270-0010-107)	(310270-0010-107)
		Ø 280 mm	700x700	(300280-0010-107)	(310280-0010-107)
		Ø 300 mm	700x700	(300300-0010-107)	(310300-0010-107)
		Ø 315 mm	700x700	(300315-0010-107)	(310315-0010-107)
		Ø 330 mm	750x750	(300330-0010-107)	(310330-0010-107)
		Ø 350 mm	750x750	(300350-0010-107)	(310350-0010-107)
Ø 355 mm	750x750	(300355-0010-107)	(310355-0010-107)		
Ø 400 mm	785x785	(300400-0010-107)	(310400-0010-107)		
Ø 450 mm	785x785	(300450-0010-107)	(310450-0010-107)		
Ø 500 mm	833x833	(300500-0010-107)	(310500-0010-107)		
Ø 510 mm	833x833	(300510-0010-107)	(310510-0010-107)		
Ø 550 mm	1000x1000	(300550-0010-107)	(310550-0010-107)		
Ø 560 mm	1000x1000	(300560-0010-107)	(310560-0010-107)		

JUAL TAGINDDÆKNING M/ PERFORERET FLANGE	ANTAL (pakn.)	DIAM. (Ø mm)	0-10°		11-32°		33-45°	
			FLANGE	(varennummer)	FLANGE	(varennummer)	FLANGE	(varennummer)
<p>Taginddækning til flade og hældningstage</p>  <p>0-10° blank aluminium</p>  <p>0-10° sortlakeret aluminium</p> <p><b>MATERIALEVALG:</b> Sortlakeret aluminium (-171)</p>	Efter ordre	80	Ø 400	(300080-0010-171)	431x415	(300080-1132-171)	458x422	(300080-3345-171)
		100	Ø 420	(300100-0010-171)	455x437	(300100-1132-171)	486x445	(300100-3345-171)
		110	Ø 430	(300110-0010-171)	467x447	(300110-1132-171)	500x456	(300110-3345-171)
		125	Ø 445	(300125-0010-171)	485x464	(300125-1132-171)	521x473	(300125-3345-171)
		140	Ø 460	(300140-0010-171)	503x480	(300140-1132-171)	542x491	(300140-3345-171)
		150	Ø 470	(300150-0010-171)	515x491	(300150-1132-171)	556x502	(300150-3345-171)
		160	Ø 480	(300160-0010-171)	527x502	(300160-1132-171)	570x513	(300160-3345-171)
		180	Ø 500	(300180-0010-171)	551x524	(300180-1132-171)	598x536	(300180-3345-171)
		187	Ø 507	(300187-0010-171)	560x531	(300187-1132-171)	607x544	(300187-3345-171)
		200	Ø 520	(300200-0010-171)	575x546	(300200-1132-171)	625x559	(300200-3345-171)
217	Ø 537	(300217-0010-171)	595x563	(300217-1132-171)	647x578	(300217-3345-171)		

Kontakt os, hvis du ønsker blank aluminium (-170)

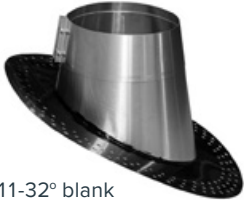

**TAGINDDÆKNINGER**  
Til rørgennemføringer på tage med forskellige hældninger og tagmaterialer

JUAL TAGINDDÆKNING M/ PERFORERET FLANGE	ANTAL (pkn.)	DIAM. (Ø mm)	0-10°		11-32°		33-45°	
			FLANGE	(varennummer)	FLANGE	(varennummer)	FLANGE	(varennummer)
Taginddækning til flade og hældningstage		224	Ø 544	(300224-0010-171)	604x572	(300224-1132-171)	659x586	(300224-3345-171)
		230	Ø 550	(300230-0010-171)	611x578	(300230-1132-171)	667x593	(300230-3345-171)
		250	Ø 570	(300250-0010-171)	636x600	(300250-1132-171)	695x616	(300250-3345-171)
		270	Ø 600	(300270-0010-171)	672x633	(300270-1132-171)	737x650	(300270-3345-171)
		280	Ø 600	(300280-0010-171)	672x633	(300280-1132-171)	737x650	(300280-3345-171)
11-32° blank aluminium		300	Ø 620	(300300-0010-171)	696x655	(300300-1132-171)	765x673	(300300-3345-171)
		315	Ø 635	(300315-0010-171)	714x671	(300315-1132-171)	786x690	(300315-3345-171)
		330	Ø 650	(300330-0010-171)	732x687	(300330-1132-171)	807x707	(300330-3345-171)
11-32° sortlakeret aluminium		350	Ø 670	(300350-0010-171)	756x709	(300350-1132-171)	834x730	(300350-3345-171)
		355	Ø 675	(300355-0010-171)	762x714	(300355-1132-171)	841x736	(300355-3345-171)
		400	Ø 720	(300400-0010-171)	816x763	(300400-1132-171)	904x787	(300400-3345-171)
	Efter ordre	450	Ø 770	(300450-0010-171)	876x818	(300450-1132-171)	974x844	(300450-3345-171)
		500	Ø 820	(300500-0010-171)	936x872	(300500-1132-171)	1043x901	(300500-3345-171)
		510	Ø 830	(300510-0010-171)	948x883	(300510-1132-171)	1057x912	(300510-3345-171)
33-45° blank aluminium		550	Ø 870	(300550-0010-171)	996x927	(300550-1132-171)	1113x958	(300550-3345-171)
		560	Ø 880	(300560-0010-171)	1008x938	(300560-1132-171)	1127x970	(300560-3345-171)
		600	Ø 920	(300600-0010-171)	1056x981	(300600-1132-171)	1183x1015	(300600-3345-171)
33-45° sortlakeret aluminium		630	Ø 950	(300630-0010-171)	1092x1014	(300630-1132-171)	1224x1050	(300630-3345-171)
		650	Ø 970	(300650-0010-171)	1117x1036	(300650-1132-171)	1252x1072	(300650-3345-171)
		700	Ø 1020	(300700-0010-171)	1177x1090	(300700-1132-171)	1322x1129	(300700-3345-171)
<b>MATERIALEVALG:</b> Sortlakeret aluminium (-171)		710	Ø 1030	(300710-0010-171)	1189x1101	(300710-1132-171)	1336x1141	(300710-3345-171)
		750	Ø 1070	(300750-0010-171)	1237x1145	(300750-1132-171)	1392x1186	(300750-3345-171)
		800	Ø 1120	(300800-0010-171)	1297x1199	(300800-1132-171)	1461x1243	(300800-3345-171)
		1000	Ø 1320	(301000-0010-171)	1537x1417	(301000-1132-171)	1740x1472	(301000-3345-171)
		Kontakt os, hvis du ønsker blank aluminium (-170)						
* 11-32° og 33-45° fra Ø 600-1000 prissættes efter ordre								





JUAL TAGINDDÆKNING M/ PERFORM INDDÆK- NINGSMATERIALE	ANTAL (pakn.)	DIAM. (Ø mm)	11-32°		33-45°		46-65°	
			FLANGE	(varennummer)	FLANGE	(varennummer)	FLANGE	(varennummer)
 <p>11-32° sort aluminium med strukturoverflade</p>  <p>33-45° sort aluminium med strukturoverflade</p>  <p>46-65° sort aluminium med strukturoverflade</p>	Efter ordre	80	940x630	(300080-1132-501)	940x630	(300080-3345-501)	940x630	(300080-4665-501)
		100	940x630	(300100-1132-501)	940x630	(300100-3345-501)	940x630	(300100-4665-501)
		110	940x630	(300110-1132-501)	940x630	(300110-3345-501)	940x630	(300110-4665-501)
		125	940x630	(300125-1132-501)	940x630	(300125-3345-501)	940x630	(300125-4665-501)
		140	940x630	(300140-1132-501)	940x630	(300140-3345-501)	940x630	(300140-4665-501)
		150	940x630	(300150-1132-501)	940x630	(300150-3345-501)	990x700	(300150-4665-501)
		160	940x630	(300160-1132-501)	940x630	(300160-3345-501)	990x700	(300160-4665-501)
		180	990x700	(300180-1132-501)	990x700	(300180-3345-501)	990x700	(300180-4665-501)
		187	990x700	(300187-1132-501)	990x700	(300187-3345-501)	990x700	(300187-4665-501)
		200	990x700	(300200-1132-501)	990x700	(300200-3345-501)	1350x800	(300200-4665-501)
		217	990x700	(300217-1132-501)	1090x800	(300217-3345-501)	1350x800	(300217-4665-501)
		224	990x700	(300224-1132-501)	1090x800	(300224-3345-501)	1350x800	(300224-4665-501)
		230	990x700	(300230-1132-501)	1090x800	(300230-3345-501)	1350x800	(300230-4665-501)
		250	1090x800	(300250-1132-501)	1090x800	(300250-3345-501)	1450x800	(300250-4665-501)
		270	1090x800	(300270-1132-501)	1090x800	(300270-3345-501)	1450x800	(300270-4665-501)
280	1090x800	(300280-1132-501)	1090x800	(300280-3345-501)	1450x800	(300280-4665-501)		
300	1090x800	(300300-1132-501)	1220x830	(300300-3345-501)	1550x900	(300300-4665-501)		
315	1090x800	(300315-1132-501)	1220x830	(300315-3345-501)	1550x900	(300315-4665-501)		

STANDARD- OG SPECIALLØSNINGER  
DER GIVER TRYGHED PÅ TAGET





Kontakt os på **76 83 11 33** eller [jual@jual.dk](mailto:jual@jual.dk)





JUAL TAGINDDÆKNING M/ PERFORM INDDÆK- NINGSMATERIALE	ANTAL (pakn.)	DIAM. (Ø mm)	11-32°		33-45°		46-65°	
			FLANGE	(varennummer)	FLANGE	(varennummer)	FLANGE	(varennummer)
 <p>11-32° sort aluminium med strukturoverflade</p>  <p>33-45° sort aluminium med strukturoverflade</p>  <p>46-65° sort aluminium med strukturoverflade</p>	Efter ordre	330	1220x830	(300330-1132-501)	1220x830	(300330-3345-501)	1650x1000	(300330-4665-501)
		350	1220x830	(300350-1132-501)	1250x900	(300350-3345-501)	1650x1000	(300350-4665-501)
		355	1220x830	(300355-1132-501)	1250x900	(300355-3345-501)	1650x1000	(300355-4665-501)
		400	1220x1000	(300400-1132-501)	1450x1000	(300400-3345-501)	1850x1100	(300400-4665-501)
		450	1220x1000	(300450-1132-501)	1450x1000	(300450-3345-501)	1850x1100	(300450-4665-501)
		500	1220x1000	(300500-1132-501)	1600x1100	(300500-3345-501)	2000x1200	(300500-4665-501)
		510	1220x1000	(300510-1132-501)	1600x1100	(300510-3345-501)	2000x1200	(300510-4665-501)
		550	1450x1100	(300550-1132-501)	1600x1100	(300550-3345-501)	2100x1200	(300550-4665-501)
		560	1450x1100	(300560-1132-501)	1600x1100	(300560-3345-501)	2100x1200	(300560-4665-501)
		600	1450x1100	(300600-1132-501)	1600x1200	(300600-3345-501)	2350x1350	(300600-4665-501)
		630	1550x1200	(300630-1132-501)	1600x1200	(300630-3345-501)	2350x1350	(300630-4665-501)
		650	1550x1200	(300650-1132-501)	1600x1200	(300650-3345-501)	2350x1350	(300650-4665-501)
		700	1550x1200	(300700-1132-501)	1800x1300	(300700-3345-501)	2450x1500	(300700-4665-501)
		710	1650x1300	(300710-1132-501)	1800x1300	(300710-3345-501)	2450x1500	(300710-4665-501)
		750	1650x1300	(300750-1132-501)	1800x1300	(300750-3345-501)	2600x1600	(300750-4665-501)
		800	1700x1400	(300800-1132-501)	1900x1400	(300800-3345-501)	2600x1600	(300800-4665-501)
		1000	1900x1600	(301000-1132-501)	1537x1417	(301000-3345-501)	3170x1850	(301000-4665-501)

TAGINDDÆKNINGER LEVERES MED  
KEGLE OG SPÆNDEBÅND, SOM ER  
**OVERFLADEBEHANDLET MED  
KRAFTIG SORT STRUKTURLAK**

# KABELGENNEMFØRING

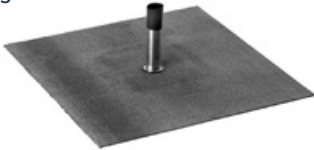
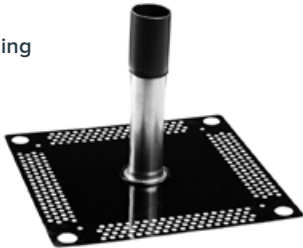
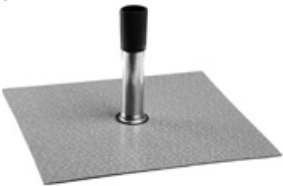
JUAL KABELGENNEMFØRING	ANTAL (pr. kolli)	RØR diameter (udvendig)	BEMÆRKNINGER	(varenummer)			
<b>Kabelgennemføring til tagpap eller tagfolie</b>  <b>MATERIALEVALG:</b> Se skema på side 19 for folier 		Ø 50 mm med SBS underpap	Rustfri stålflange, ekstra kraftig rustfrit stålrør Ø 50 mm Bøjning – 180° Fremstillet i ét stykke	(220054-107)			
		Ø 50 mm med APP tagpap		(220054-114)			
		Ø 50 mm med overpap Phønix sort		(220054-109)			
		Ø 50 mm med overpap Phønix kulsort		(220054-110)			
		Ø 50 mm med overpap Top500 Icopal		(220054-111)			
		Ø 50 mm med Derbigum		(220054-103)			
		Ø 50 mm med kunde- specificeret tagpap		(220054-199)			
		Ø 50 mm med tagfolie*		(220054-2xx)			
		<b>Kabelgennemføring til skråt tag 11-55°</b> 		Efter ordre	Ø 32 mm med SBS underpap	Rustfri stålflange rustfrit stålrør Ø 32 mm Rørstykke fremstillet i ét stykke med krympeflex	(220055-101)
					Ø 32 mm med APP tagpap		(220055-114)
Ø 32 mm med overpap Phønix sort	(220055-109)						
Ø 32 mm med overpap Phønix kulsort	(220055-110)						
Ø 32 mm med overpap Top500 Icopal	(220055-111)						
Ø 32 mm med Derbigum	(220055-103)						
<b>Kabelgennemføring til tagpap</b>  <b>MATERIALEVALG:</b> SBS: (-101) APP: (-114) 		Ø 75 mm	Med 2 stk. plastbøjninger	(71075KP-P-1xx)			
		Ø 110 mm	Med 2 stk. plastbøjninger	(71110KP-P-1xx)			
		Ø 75 mm	Med 2 stk. rustfri stålbøjninger	(71075KP-R-1xx)			
		Ø 110 mm	Med 2 stk. rustfri stålbøjninger	(71110KP-R-1xx)			
<b>Kabelgennemføring til Derbigum tagpap</b> 		Ø 75 mm	Med 2 stk. plastbøjninger	(71075KP-P-103)			
		Ø 110 mm	Med 2 stk. plastbøjninger	(71110KP-P-103)			
		Ø 75 mm	Med 2 stk. rustfri stålbøjninger	(71075KP-R-103)			
		Ø 110 mm	Med 2 stk. rustfri stålbøjninger	(71110KP-R-103)			
<b>Kabelgennemføring til tagfolie</b>  <b>MATERIALEVALG:</b> Se skema på side 19 for folier 		Ø 75 mm	Med 2 stk. plastbøjninger	(71075KF-P-2xx)			
		Ø 110 mm	Med 2 stk. plastbøjninger	(71110KF-P-2xx)			
		Ø 75 mm	Med 2 stk. rustfri stålbøjninger	(71075KF-R-2xx)			
		Ø 110 mm	Med 2 stk. rustfri stålbøjninger	(71110KF-R-2xx)			

JUAL KRYMPEINDDÆKNING	ANTAL (pr. kolli)	ANVENDELSE	PASSER TIL	(varenummer)
Krympeinddækning i rustfrit stål med tagpapflange  <b>MATERIALEVALG:</b> SBS: (-101) APP: (-114)	5 stk.	Krympeinddækning til lodret inddækning	Ø 27-10 mm	(71027-10-1xx)
			Ø 45-20 mm	(71045-20-1xx)
			Ø 75-30 mm	(71075-30-1xx)
			Ø 105-50 mm	(71105-50-1xx)
			Ø 120-75 mm	(71120-75-1xx)
	Ø 155-80 mm	(71155-80-1xx)		
Krympeinddækning i rustfrit stål med tagpapflange Derbigum 		Krympeinddækning til lodret inddækning	Ø 27-10 mm	(71027-10-103)
			Ø 45-20 mm	(71045-20-103)
			Ø 75-30 mm	(71075-30-103)
			Ø 105-50 mm	(71105-50-103)
			Ø 120-75 mm	(71120-75-103)
			Ø 155-80 mm	(71155-80-103)
Krympeinddækning i rustfrit stål med stålflange 		Krympeinddækning til lodret inddækning	Ø 27-10 mm	(71027-10-190)
			Ø 45-20 mm	(71045-20-190)
			Ø 75-30 mm	(71075-30-190)
			Ø 105-50 mm	(71105-50-190)
			Ø 120-75 mm	(71120-75-190)
			Ø 155-80 mm	(71155-80-190)
Krympeinddækning i rustfrit stål med tagfolieflange  Se skema på side 19 for folier		Krympeinddækning til lodret inddækning	Ø 27-10 mm	(71027-10-2xx)
			Ø 45-20 mm	(71045-20-2xx)
			Ø 75-30 mm	(71075-30-2xx)
			Ø 105-50 mm	(71105-50-2xx)
			Ø 120-75 mm	(71120-75-2xx)
			Ø 155-80 mm	(71155-80-2xx)

JUAL SPÆNDEBÅND	ANTAL (pr. kolli)	BEMÆRKNING	DIMENSION (LxBxH mm)	(varenummer)
Spændebånd Firkantet 1,5 mm rustfrit stål 	Efter ordre	To-delt til firkantet emne m/ 2 bolte og møtrikker	50 x 50 x 40 mm	(300000)
			75 x 75 x 40 mm	(300001)
			100 x 100 x 40 mm	(300002)
Spændebånd Firkantet med fugekant 1,5 mm rustfrit stål 		To-delt til firkantet emne m/ 2 bolte og møtrikker	50 x 50 x 40 mm	(301000)
			75 x 75 x 40 mm	(301001)
			100 x 100 x 40 mm	(301002)

# SIKKERHEDSANKRE

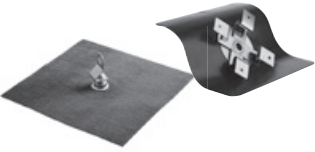
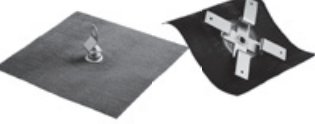
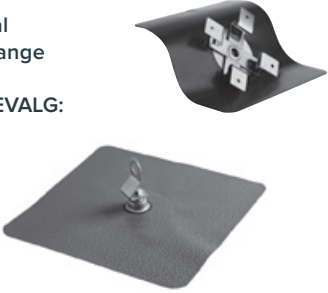
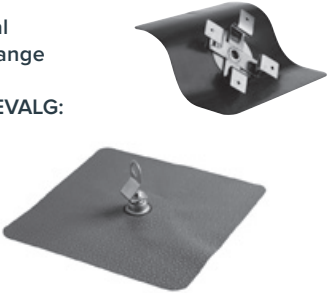





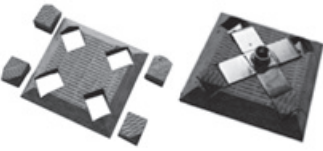

JUAL SIKKERHEDSANKRE	ANTAL (pr. kolli)	ANVENDELSE	BESKRIVELSE	(varenummer)
<b>JSA 177</b> <b>JUAL Sikkerhedsanker</b> i rustfrit stål med tagpap-flange 		Til beton/trædæk med/uden isolering	JSA med SBS underpap	(260000-107)
			JSA med APP	(260000-114)
			JSA med kundepap	(260000-199)
<b>JSA 250</b> <b>JUAL Sikkerhedsanker</b> i rustfrit stål med tagpap-flange 		Til tag med trapez-plader med isolering	JSA med SBS underpap	(260001-107)
			JSA med APP	(260001-114)
			JSA med kundepap	(260001-199)
<b>JSA 177</b> <b>JUAL Sikkerhedsanker</b> i rustfrit stål med folieflange <b>MATERIALEVALG:</b> Se skema på side 19 for folier 	Efter ordre	Til beton/trædæk med/uden isolering	JSA med mørk grå Alkorplan PVC	(260000-201)
			JSA med lys grå Alkorplan PVC	(260000-202)
			JSA med mørk grå Protan PVC	(260000-203)
			JSA med lys grå Protan PVC	(260000-204)
			JSA med mørk grå Sarnafil PVC	(260000-206)
			JSA med lys grå Sarnafil PVC	(260000-207)
			JSA med kundefolie	(260000-299)
<b>JSA 250</b> <b>JUAL Sikkerhedsanker</b> i rustfrit stål med folieflange <b>MATERIALEVALG:</b> Se skema på side 19 for folier 		Til tag med trapez-plader med isolering	JSA med mørk grå Alkorplan PVC	(260001-201)
			JSA med lys grå Alkorplan PVC	(260001-202)
			JSA med mørk grå Protan PVC	(260001-203)
			JSA med lys grå Protan PVC	(260001-204)
			JSA med mørk grå Sarnafil PVC	(260001-206)
			JSA med lys grå Sarnafil PVC	(260001-207)
			JSA med kundefolie	(260001-299)

## JSA SIKKERHEDSANKER

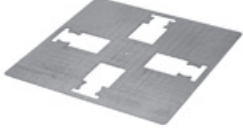
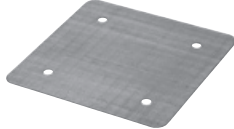
SIKKER MONTERING PÅ ALLE FLADE TAGE MED TAGPAP ELLER TAGFOLIE



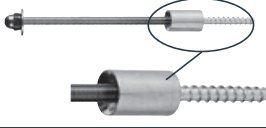
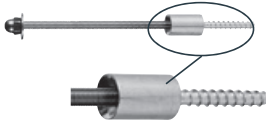

**KAN MONTERES OPPEFRA PÅ DET FÆRDIGE TAG**



JUAL SIKKERHEDSANKRE	ANTAL (pr. kolli)	ANVENDELSE	(varenummer)
JSA Isoleringskile 	Efter ordre	Til isolering af JSA på trædæk Isoleringskile til JSA 177 på træ (300 x 300 x 45 mm med udskæringer) Isoleringskile til JSA 250 på træ (400 x 400 x 45 mm med udskæringer)	(260019-177) (260019-250)
JSA Isoleringsbor 	Efter ordre	Ø 50 x 600 mm Til udskæring af isolering og centrering af borehul. Rockwool, Styropor, Mineraluld	(260010)
JSA 177 Skabelon Beton/træ – Varmt tag med pålagt isolering 		Til opmærkning for udskæring af membran og isolering ved montage af JSA 177	(260011)
JSA 250 Skabelon Trapezplade med pålagt isolering 		Til opmærkning for udskæring af membran og isolering ved montage af JSA 250	(260012)
JSA 177 Støtteplade Trædæk – Koldt tag 		Støtteplade til montage af JSA 177 på trædæk	(260013)
JSA 250 Støtteplade Trædæk 	Efter ordre	Støtteplade til montage af JSA 250 på trædæk	(260014)
JSA Kipanker 15 mm 		Til montage på trædæk. Trædæk tykkelse max. 35 mm M10 – gevindlængde over tagdæk 15 mm	(260015-15)
JSA Kipanker 500 mm 		Til trædæk og trapez-plader på varmt tag. Trædæk-tykkelse op til 35 mm Trapez-plade min. 0,75 mm M10 – gevindlængde over tagdæk 500 mm	(260016-500)
JSA Kipanker 800 mm 		Til trædæk og trapez-plader på varmt tag. Trædæk-tykkelse op til 35 mm Trapez-plade min. 0,75 mm M10 – gevindlængde over tagdæk 800 mm	(260016-800)
JSA Betonanker 500 mm 	Efter ordre	Til montage i betondæk på varmt tag M10 – gevindlængde over tagdæk 500 mm	(260017-500)
JSA Betonanker 800 mm 		Til montage i betondæk på varmt tag M10 – gevindlængde over tagdæk 800 mm	(260017-800)
M10 Gevind-bit 	Efter ordre	For korrekt iskruning og montage af JSA Kipanker	(260018)



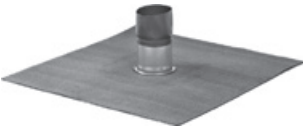

## SIKKERHEDSØSKNER ANVENDES SOM ANKERPUNKTER TIL SIKKERHEDSUDSTYR



JUAL SIKKERHEDSØSKEN MED TILBEHØR	ANTAL (pr. kolli)	BESKRIVELSE	(varenummer)
Sikkerhedsøsken Ø 20 mm 		Højde 300 mm Højde 400 mm Højde 500 mm Højde 600 mm	(93744R) (93755R) (93766R) (93777R)
Kontraplade for fastspænding 50 x 200 mm 	Efter ordre	Kit inkl. 2 kontraplader, 4 gevindtænger samt møtrikker og skiver	(93799)
Inddækning til sikkerhedsøsken  <b>MATERIALEVALG:</b> Se skema på side 19 for folier 		Pap / rustfrit stål Ø 20 mm SBS Pap / rustfrit stål Ø 20 mm Derbigum Folie* / rustfrit stål Ø 20 mm	(71027-10-101) (71027-10-103) (71027-10-2xx)
<b>PLASTIGEN</b> Inddækning til sikkerhedsøsken Ø 20 mm 		Glasfiber-armeret nylon (til tagpap) PVC (til PVC-folie)	(93811) (93833)

JUAL Sikkerhedsøsken er testet og godkendt af Force Technology

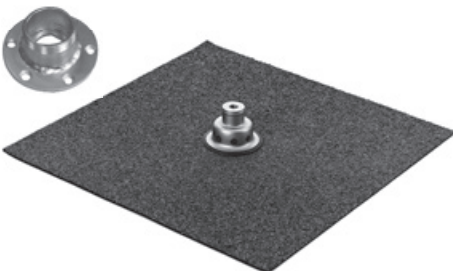
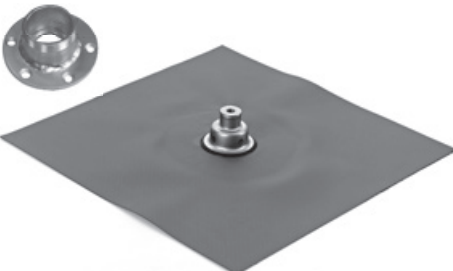
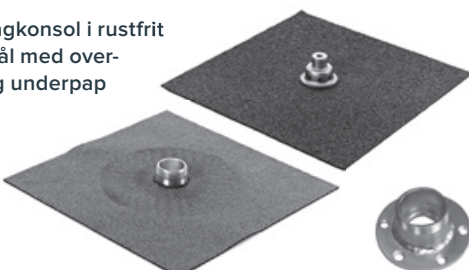

# TAGKONSOLLER

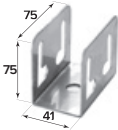
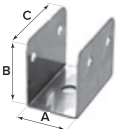
JUAL TAGKONSOL	ANTAL (pr. kolli)	BESKRIVELSE	(varenummer)
<b>KONSOLSYSTEM – 1-LAGSLØSNING</b>			
Tagkonsol i rustfrit stål med tagpapflange 	Efter ordre	JUAL Tagkonsol med SBS underpap, inkl. gevindklump	(220060-107)
		JUAL Tagkonsol med APP underpap, inkl. gevindklump	(220060-114)
		JUAL Tagkonsol med overpap Phønix sort, inkl. gevindklump	(220060-109)
		JUAL Tagkonsol med overpap Phønix kulsort, inkl. gevindklump	(220060-110)
		JUAL Tagkonsol med overpap Top500 Icopal, inkl. gevindklump	(220060-111)
		JUAL Tagkonsol med Derbigum, inkl. gevindklump	(220060-103)
		JUAL Tagkonsol med kundespecificeret tagpap, inkl. gevindklump	(220060-199)
Tagkonsol i rustfrit stål med PVC folieflange  <b>MATERIALEVALG:</b> Se skema på side 19 for folier	Efter ordre	JUAL Tagkonsol med PVC folie, mørk grå Alkorplan, inkl. gevindklump	(220060-201)
		JUAL Tagkonsol med PVC folie, lys grå Alkorplan, inkl. gevindklump	(220060-202)
		JUAL Tagkonsol med PVC folie, mørk grå Protan, inkl. gevindklump	(220060-203)
		JUAL Tagkonsol med PVC folie, lys grå Protan, inkl. gevindklump	(220060-204)
		JUAL Tagkonsol med PVC folie, mørk grå Sarnafil, inkl. gevindklump	(220060-206)
		JUAL Tagkonsol med PVC folie, lys grå Sarnafil, inkl. gevindklump	(220060-207)
		JUAL Tagkonsol med kundespecificeret PVC folie, inkl. gevindklump	(220060-299)
<b>KONSOLSYSTEM – 2-LAGSLØSNING</b>			
Tagkonsol i rustfrit stål med over- og underpap 	Efter ordre	JUAL Tagkonsol med overpap Phønix sort inkl. gevindklump, med underpap	(230060-109)
		JUAL Tagkonsol med overpap Phønix kulsort inkl. gevindklump, med underpap	(230060-110)
		JUAL Tagkonsol med overpap Icopal Top500 inkl. gevindklump, med underpap	(230060-111)
		JUAL Tagkonsol med kundespecificeret overpap inkl. gevindklump, med underpap	(230060-199)
<b>TÆTNING OG TRYKAFLASTNING</b>			
Gummiprop for gevindklump 	Efter ordre	Anvendes til montagetætning og/eller trykaflastning. Prop tykkelse = 12 mm. Prop diameter = Ø 37 mm	(221500)

JUAL KONSOLBESLAG	ANTAL (pr. kolli)	BESKRIVELSE	(varenummer)
40 mm standard-gaffel 	Efter ordre	40 mm standard-gaffel med bolt, rustfrit stål	(240001)
Special-gaffel 		Gaffel i henhold til kundetegning, med bolt, rustfrit stål	(240002)
Pinbolt 		Pinbolt M12x80 med 3 kontramøtrikker, rustfrit stål	(240010)

JUAL KONSOLANKRE	ANTAL (pr. kolli)	BESKRIVELSE	(varenummer)
<b>KONSOLANKRE FOR KOLDT TAG</b>			
Kipanker 	Efter ordre	Kipanker – L: 120 mm	(210065)
Træskruer 		Træskruer – L: 100 mm med skive	(210066)
Betonbolt 		Betonbolt – L: 80 mm med skive	(210067)
<b>KONSOLANKRE FOR VARMT TAG</b>			
Beton-anker 	Efter ordre	Beton-anker med 500 mm rustfri gevindstang med betonskrue og teleskopmøtrik	(210062)
Træ-anker 		Træ-anker med 500 mm rustfri gevindstang med træskruer og teleskopmøtrik	(210063)
Trapez-anker 		Trapez-anker med 500 mm rustfri gevindstang med kipanker og teleskopmøtrik	(210064)
Letbeton-anker 		Letbeton-anker med 500 mm rustfri gevindstang med skrue og rawplug	(210077)
JUAL Horizontal forstærkning 		JUAL Horizontal forstærkning	(210030)

TAGINDDÆKNING TIL ANDEN FASTGØRELSE	ANTAL (pr. kolli)	ANVENDELSE	(varenummer)
Ansatsskrue 	Efter ordre	Ansatskrue til hældningstag (M12 x 200)	(215001)
Kipanker til hældningstag 		Kipanker til hældningstag (M10 x 200)	(215002)

TAGINDDÆKNING TIL ANDEN FASTGØRELSE – INDDÆKNING	ANTAL (pr. kolli)	ANVENDELSE	BESKRIVELSE	(varenummer)
Taginddækning til ansatsskrue/kipanker m.v.   <b>TÜVRheinland®</b> Precisely Right. TÜV Rheinland-testet. Godkendt i henhold til DS/EN-1253.	Efter ordre	Kun til taghældning på over 11°	Inddækning med overpap Phønix sort Inddækning med overpap Phønix kulsort Inddækning med overpap Icopal Top500 Inddækning med overpap med kundespecificeret overpap	(225000-109) (225000-110) (225000-111) (225000-199)



# INDDÆKNINGSMATERIALE

INDDÆKNINGSMATERIALE		ANTAL (pr. kolfi)	FARVE	(varenummer)
PERFORM Inddækningsmateriale Rulle 250 x 4000 mm		1 stk.	Grå	(288050025)
			Sort	(288051025)
	Rød		(288052025)	
PERFORM Inddækningsmateriale Rulle 310 x 4000 mm			Grå	(288050031)
	Sort		(288051031)	
	Rød		(288052031)	
PERFORM Inddækningsmateriale Rulle 410 x 4000 mm			Grå	(288050041)
			Sort	(288051041)
	Rød		(288052041)	
PERFORM Inddækningsmateriale Rulle 1250 x 4000 mm			Grå	(288050125)
	Sort		(288051125)	
	Rød		(288052125)	
PERFORM Klæber Patron á 290 ml			Grå	(288059532)
			Sort	(288059529)
		Rød	(288059534)	
PERFORM Hæfter Til ophæftning, 20 g		-	(288059102)	
PERFORM Hammer		-	(288058000)	

I JUAL HAR DU EN STÆRK SAMARBEJDS-  
PARTNER MED 50 ÅRS ERFARING.  
**VI SÆTTER EN ÆRE I AT BETJENE  
DIG HURTIGT OG KOMPETENT**

KONTAKT OS PÅ  
76 83 11 33 // JUAL@JUAL.DK

# DIVERSE TAGTILBEHØR

JUAL HJÆLPEVÆRKTØJ		ANTAL (pr. kolli)	BESKRIVELSE	(varenummer)
Smigmåler		1 stk.	Digital smigmåler	(230001)
Udlægningsrulle Til udlægning af tagpap			Ø 80 mm – 2,0 mm aluminium Længde = 980 mm	(80980)
Udlægningsrulle Til udlægning af tagpap			Ø 100 mm – 2,0 mm aluminium Længde = 980 mm	(100980)
Udlægningsrulle Til udlægning af tagpap			Ø 150 mm – 3,0 mm aluminium Længde = 980 mm	(150980)

JUAL RÆKVÆRKSPLADE		ANTAL (pr. kolli)	BESKRIVELSE	(varenummer)
Rækværksplade		50 stk.	Holder for midlertidig rækværk	(93910)

JUAL TAGTRIN		ANTAL (pr. kolli)	MATERIALE / FARVE	(varenummer)
JUAL Tagtrin til tagpaptag		10 stk.	Aluzink/Sort	(88405)

ALU. SØM (kun hele pakninger)	TEGNING	ANTAL (pr. kolli)	DIMENSION	(varenummer)
Alu. kamsøm med neopren- skive		500 stk.	3,5 x 37 mm m /skive	(90100)

## SALG & SUPPORT



**Brian Kondrup Sørensen**  
Salgschef  
E: bs@jual.dk  
M: +45 20 47 92 10



**Rene Jørgensen**  
Intern salgskonsulent  
E: rj@jual.dk



**Carsten Christiansen**  
Intern salgskonsulent  
E: cc@jual.dk



**Olle Jansved**  
Intern salgskonsulent  
E: oj@jual.dk



**Vivian Nielsen**  
Intern salgsassistent  
E: vn@jual.dk



**Kjeld Bruun**  
Projektchef  
E: kb@jual.dk  
M: +45 22 37 43 24



**Patrick Eskerod Jensen**  
Salgselev  
E: pj@jual.dk



**Svend Aage Nielsen**  
Intern rådgiver  
Salg og ekspedition  
E: saan@jual.dk



**Anette Brændgaard**  
Eksportkoordinator  
E: aeb@jual.dk



**Jacob Kjær Jørgensen**  
Salgs- og marketingchef  
E: jkj@jual.dk  
M: +45 26 84 07 45

## CHAUFFØRER



**Henrik Eriksen**  
Chauffør  
M: +45 20 26 39 60



**Allan Nielsen**  
Chauffør  
M: +45 40 11 60 33

## ADMINISTRATION



**Ib Floutrup**  
Adm. direktør  
E: if@jual.dk



**Anette Spliid Laursen**  
Økonomi- og  
administrationschef  
E: asl@jual.dk



**Dorthe Laursen**  
Økonomiasistent  
E: dl@jual.dk

## PRODUKTTEKNIK



**Lars Hansen**  
Teknisk sælger  
Teknisk salg & support  
E: lh@jual.dk



**John Rosenmeyer**  
Anvendelsestekniker  
E: jro@jual.dk  
Tlf. 20 47 62 32

## KONTAKT OS

Ring til os på **telefon 76 83 11 33**  
eller skriv til [jual@jual.dk](mailto:jual@jual.dk)

Vi glæder os til at hjælpe dig  
videre med dit projekt

Mandag – torsdag 7.00 – 16.00    Fredag 7.00 – 14.00



JUAL A/S, Industrivej 14  
DK-7130 Juelsminde  
E: [jual@jual.dk](mailto:jual@jual.dk)  
T: +45 76 83 11 33  
W: [jual.dk](http://jual.dk)

JUAL A/S er en del af JUAL GROUP

JUAL GROUP består af selskaberne:  
JUAL A/S, JUAL Kina, JUAL Solar A/S,  
Bygtjek A/S og Perform A/S  
Se mere på [www.jualgroup.dk](http://www.jualgroup.dk)

